

# P

Paulmann



News 2016





**Sol**

incl. 1x7 W  
820 lm, 3000 K  
ø195 ↗40 mm  
EAN 4000870 707357  
**707.35 new**



☞ Bílá ☒ Kov  
☞ Biały ☒ Metal  
☞ Белый ☒ Металл



**Sol**

incl. 1x7 W  
870 lm, 3000 K  
↕195 ⇔195 ↗40 mm  
EAN 4000870 707326  
**707.32 new**



☞ Bílá ☒ Kov  
☞ Biały ☒ Metal  
☞ Белый ☒ Металл



**Sol**

incl. 1x12,2 W  
1415 lm, 3000 K  
ø245 ↗40 mm  
EAN 4000870 707364  
**707.36 new**



☞ Bílá ☒ Kov  
☞ Biały ☒ Metal  
☞ Белый ☒ Металл



**Sol** A++-A  
 incl. 1x12,2 W  
 1390 lm, 3000 K  
 ⌀245 ⇄245 ⌀40 mm  
 EAN 4000870 707333  
**707.33 new**

LED  
 [Icon: Square with grid]  
 [Icon: Sun]

- ☞ Bílá ☒ Kov
- ☞ Biały ☒ Metal
- ☞ Белый ☒ Металл



**Sol** A++-A  
 incl. 1x9,4 W / 1x4,6 W  
 930 lm, 3000 K  
 12 VA  
 ⌀245 ⇄245 ⌀40 mm  
 EAN 4000870 707340  
**707.34 new**

LED  
 [Icon: Remote]  
 [Icon: Remote with 'incl.']  
 [Icon: Color wheel]  
 [Icon: Flash]  
 [Icon: Square with grid]  
 [Icon: Sun]

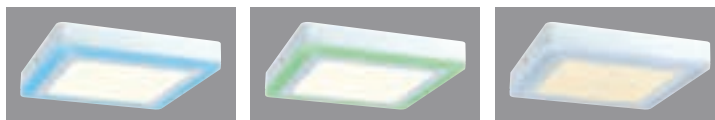

- ☞ Bílá ☒ Kov
- ☞ Biały ☒ Metal
- ☞ Белый ☒ Металл



**Sol** A++-A  
 incl. 1x9,4 W / 1x4,6 W  
 940 lm, 3000 K  
 12 VA  
 ⌀245 ⌀40 mm  
 EAN 4000870 707371  
**707.37 new**

LED  
 [Icon: Remote]  
 [Icon: Remote with 'incl.']  
 [Icon: Color wheel]  
 [Icon: Flash]  
 [Icon: Square with grid]  
 [Icon: Sun]

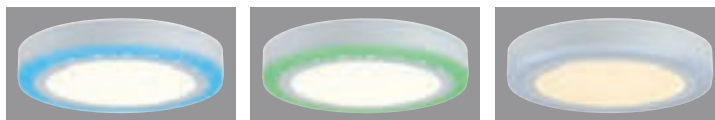

- ☞ Bílá ☒ Kov
- ☞ Biały ☒ Metal
- ☞ Белый ☒ Металл



**Ixa**

max. 18W, E27  
230V  
ø310 ø110 mm  
EAN 4000870 708057

**708.05 new**

⦿ 283.31 6W  
283.77 7,5W

A++-E



⌘ Kartáčované železo/Bílá ☒ Kov/Akryl  
⌘ Żelazo szczotkowane/Biały ☒ Metal/Akryl  
⌘ Железо шероховатое/Белый  
☒ Металл/Акрил



**Biabo**

max. 18W, E27  
230V  
ø250 ø105 mm  
EAN 4000870 708040

**708.04 new**

⦿ 283.31 6W  
283.77 7,5W

A++-E



⌘ Chrom/Bílá ☒ Kov/Akryl  
⌘ Chrom/Biały ☒ Metal/Akryl  
⌘ Хром/Белый ☒ Металл/Акрил



**Falima**

max. 18W, E27  
230V  
ø260 ø105 mm  
EAN 4000870 708064

**708.06 new**

⦿ 283.31 6W  
283.77 7,5W

A++-E



⌘ Chrom/Bílá ☒ Kov/Akryl  
⌘ Chrom/Biały ☒ Metal/Akryl  
⌘ Хром/Белый ☒ Металл/Акрил

- ▶ Reproduktory ovládané pomocí Bluetooth
- ▶ Plynulá regulace bílé barvy světla
- ▶ 4stupňový stmívač
- ▶ Funkce nočního světla
- ▶ Efekt hvězdné oblohy
- ▶ Głośnik regulowany przez bluetooth
- ▶ Płynny wybór białej barwy światła
- ▶ 4-stopniowy ściemniacz
- ▶ Funkcja światła nocnego
- ▶ Efekt gwiazdzistego nieba
- ▶ Динамик регулируется через Bluetooth
- ▶ Плавная регулировка для выбора одного из вариантов белого цвета освещения
- ▶ 4-ступенчатый светорегулятор
- ▶ Функция ночного освещения
- ▶ Эффект «звездного неба»



🎵 Bílá 📦 Plast  
 🎵 Biały 📦 Tworzywo sztuczne  
 🎵 Белый 📦 Пластмасса





**Accento** A++-A

incl. 1x22 W / 1x3 W 🗣️

2150 lm, 3000 - 6500 K

230-240 V

ø340 ⚙️85 mm

EAN 4000870 706220

**706.22 new**

LED

📶

🌙

IP44

📏

🔌



🎵 Matně bílý/Matný chrom/Průhledná 📦 Kov/Akryl  
 🎵 Biel matowa/Chrom matowy/Przezroczysty 📦 Metal/Akryl  
 🎵 Белый матовый/Хром матовый/Прозрачный 📦 Металл/Акрил

🎵 Matně bílý/Matný chrom/Průhledná 📦 Kov/Akryl  
 🎵 Biel matowa/Chrom matowy/Przezroczysty 📦 Metal/Akryl  
 🎵 Белый матовый/Хром матовый/Прозрачный 📦 Металл/Акрил



**DecoBeam** A++-A

incl. 1x4,5 W

451 lm, 3000 K

230 V, 7 VA

⚙️54 ø250 mm

EAN 4000870 707210

**707.21 new**

LED

📶

🌙



**DecoBeam** A++-A

incl. 1x3,5 W

330 lm, 3000 K

230 V, 7 VA

⚙️54 ø150 mm

EAN 4000870 707203

**707.20 new**

LED

📶

🌙



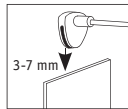

#### Mirror Simplo LED

A++-E

incl. 1×5,3 W, GU10, A+

345 lm

∠ 36°, 650 cd

230 V

∅60 ∅51 ↔30 ↗100 mm

EAN 4000870 999059

**999.05 new**

⊙ 284.34 5,7 W

284.10 5,3 W

🌀 Kartáčované železo 🗄 Kov

🌀 Źelazo szcztkowane 🗄 Metal

🌀 Железо шероховатое

🗄 Металл

LED

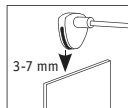

#### Mirror Vitrino LED

A++-E

incl. 1×2,2 W, G9, A+

200 lm

230 V

∅125 ∅35 ↔15 ↗100 mm

EAN 4000870 999073

**999.07 new**

⊙ 283.38 2,2 W

284.46 3 W

🌀 Kartáčované železo/Opál

🗄 Kov/Sklo

🌀 Źelazo szcztkowane/Opal

🗄 Metal/Szkło

🌀 Железо шероховатое/Opal

🗄 Металл/Стекло

LED

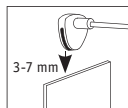

#### Mirror Curvus LED

A++-E

incl. 1×2,2 W, G9, A+

200 lm

230 V

∅230 ∅60 ↔30 ↗120 mm

EAN 4000870 999066

**999.06 new**

⊙ 283.38 2,2 W

284.46 3 W

🌀 Kartáčované železo/Opál

🗄 Kov/Sklo

🌀 Źelazo szcztkowane/Opal

🗄 Metal/Szkło

🌀 Железо шероховатое/Opal

🗄 Металл/Стекло

LED



#### Mirror Calami LED

A++-E

incl. 2×2,2 W, G9, A+

200 lm

230 V

∅60 ↔275 ↗190 mm

EAN 4000870 998670

**998.67 new**

⊙ 283.38

🌀 Kartáčované železo 🗄 Kov

🌀 Źelazo szcztkowane 🗄 Metal

🌀 Железо шероховатое

🗄 Металл

LED



On/Off



**Galeria LED II**

A++-E

incl. 2x4 W, GU5,3,  $\langle A^+ \rangle$ 

230 lm

 $\sphericalangle$  38°, 500 cd

230 V

 $\updownarrow$ 300  $\varnothing$ 51  $\leftrightarrow$ 25  $\nearrow$ 180 mm

EAN 4000870 999080

**999.08 new**

☎ 283.01

☞ Chrom ☐ Kov

☞ Chrom ☐ Metal

☞ Хром ☐ Металл

LED

**Assistent II LED**

A++-E

incl. 2x4 W, GU5,3,  $\langle A^+ \rangle$ 

230 lm

 $\sphericalangle$  38°, 500 cd

230 V

 $\updownarrow$ 170  $\varnothing$ 51  $\leftrightarrow$ 25  $\nearrow$ 460 mm

EAN 4000870 999097

**999.09 new**

☎ 283.01

☞ Chrom ☐ Kov

☞ Chrom ☐ Metal

☞ Хром ☐ Металл

LED

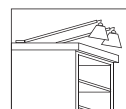
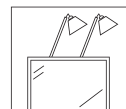
**Assistent Butler LED**

A++-E

incl. 2x4 W, GU5,3,  $\langle A^+ \rangle$ 

230 lm

 $\sphericalangle$  38°, 500 cd $\updownarrow$ 50  $\leftrightarrow$ 32  $\nearrow$ 170-600 mm

EAN 4000870 999004

**999.00 new**

☎ 283.01

☞ Černá ☐ Kov

☞ Czarny ☐ Metal

☞ черный ☐ Металл

LED

**Assistent Finja LED**

A++-E

incl. 1x6,5 W, GU10,  $\langle A^+ \rangle$ 

425 lm

 $\sphericalangle$  38°, 950 cd

230 V

 $\updownarrow$ 330  $\varnothing$ 51  $\leftrightarrow$ 115 mm

EAN 4000870 998687

**998.68 new**

☎ 284.10 5,3 W

283.00 6,5 W

☞ Matný chrom ☐ Kov/Plast

☞ Chrom matowy

☐ Metal/Tworzywo sztuczne

☞ Хром матовый

☐ Металл/Пластмасса

LED

On/Off

**Assistent Gesa LED**

A++-E

incl. 1x3,5 W, GU10,  $\langle A^+ \rangle$ 

230 lm

 $\sphericalangle$  38°, 550 cd

230 V

 $\updownarrow$ 282  $\varnothing$ 51  $\leftrightarrow$ 115 mm

EAN 4000870 999103

**999.10 new**

☎ 282.99 3,5 W

284.10 5,3 W

☞ Matný chrom ☐ Kov/Plast

☞ Chrom matowy

☐ Metal/Tworzywo sztuczne

☞ Хром матовый

☐ Металл/Пластмасса

LED

On/Off





☞ Matně bílý/Chrom ☒ Kov  
☞ Biel matowa/Chrom ☒ Metal  
☞ Белый матовый/Хром ☒ Металл



**Frame**

incl. 1×4,5W  
 468lm, 3000K  
 230V  
 ⌀140 ⇔88 ⤴131mm  
 EAN 4000870 666388

**666.38 new**

A++-A

LED



**Frame**

incl. 2×4,5W  
 468lm, 3000K  
 230V  
 ⌀131 ⇔280 ⤴100mm  
 EAN 4000870 666395

**666.39 new**

A++-A

LED



**Frame**

incl. 3×4,5W  
 468lm, 3000K  
 230V  
 ⌀131 ⇔430 ⤴100mm  
 EAN 4000870 666401

**666.40 new**

A++-A

LED



**Frame**

incl. 4×4,5W  
 468lm, 3000K  
 230V  
 ⌀131 ⇔250 ⤴250mm  
 EAN 4000870 666418

**666.41 new**

A++-A

LED







⚙ Chrom ☒ Kov  
 ⚙ Chrom ☒ Metal  
 ⚙ Хром ☒ Металл



**Mic** A++-A  
 incl. 1×4,5W  
 489lm, 3000K  
 230V  
 ⌀80 ⇔140 ⤴160mm  
 EAN 4000870 666425  
**666.42 new**



**Mic** A++-A  
 incl. 2×4,5W  
 489lm, 3000K  
 230V  
 ⌀160 ⇔280 ⤴80mm  
 EAN 4000870 666432  
**666.43 new**



**Mic** A++-A  
 incl. 3×4,5W  
 489lm, 3000K  
 230V  
 ⌀160 ⇔430 ⤴80mm  
 EAN 4000870 666449  
**666.44 new**



**Mic** A++-A  
 incl. 4×4,5W  
 489lm, 3000K  
 230V  
 ⌀160 ⇔250 ⤴250mm  
 EAN 4000870 666456  
**666.45 new**



⚙ Chrom/Čirá ☒ Kov/Akryl  
 ⚙ Chrom/Przezroczysty ☒ Metal/Akryl  
 ⚙ Хром/Прозрачный ☒ Металл/Акрил



**Window** A++-A  
 incl. 1×5W  
 381lm, 3000K  
 230V  
 ⌀180 ⇔80 ⤴100mm  
 EAN 4000870 666661  
**666.66 new**



**Window** A++-A  
 incl. 2×5W  
 381lm, 3000K  
 230V  
 ⌀190 ⇔308 ⤴80mm  
 EAN 4000870 666678  
**666.67 new**



**Window** A++-A  
 incl. 3×5W  
 381lm, 3000K  
 230V  
 ⌀190 ⇔385 ⤴80mm  
 EAN 4000870 666685  
**666.68 new**



**Window** A++-A  
 incl. 4×5W  
 381lm, 3000K  
 230V  
 ⌀200 ⇔795 ⤴80mm  
 EAN 4000870 666692  
**666.69 new**



⚙ Chrom ☒ Kov  
 ⚙ Chrom ☒ Metal  
 ⚙ Хром ☒ Металл



**Egg LED** A++-A

incl. 1×4,2 W LED

490 lm, 2700 K On/Off

230 V

⌀148 ⇄100 ⚙100 mm

EAN 4000870 603284

**603.28 new**

**Egg LED** A++-A

incl. 2×4,2 W LED

490 lm, 2700 K

230 V

⌀170 ⇄320 ⚙100 mm

EAN 4000870 603291

**603.29 new**

**Egg LED** A++-A

incl. 3×4,2 W LED

490 lm, 2700 K

230 V

⌀170 ⇄530 ⚙100 mm

EAN 4000870 603307

**603.30 new**

**Egg LED** A++-A

incl. 4×4,2 W LED

490 lm, 2700 K

230 V

⌀170 ⇄674 ⚙100 mm

EAN 4000870 603314

**603.31 new**



⚙ Hliník kartáčovaný/Chrom ☒ Kov  
 ⚙ Alu satynowane/Chrom ☒ Metal  
 ⚙ Алюминий брашированный/Хром  
 ☒ Металл



**Hemisphere** A++-A

incl. 1×4,5 W LED

439 lm, 3000 K On/Off

230 V

⌀80 ⇄178 ⚙130 mm

EAN 4000870 666302

**666.30 new**

**Hemisphere** A++-A

incl. 2×4,5 W LED

439 lm, 3000 K

230 V

⌀130 ⇄310 ⚙80 mm

EAN 4000870 666319

**666.31 new**

**Hemisphere** A++-A

incl. 3×4,5 W LED

439 lm, 3000 K

230 V

⌀130 ⇄470 ⚙80 mm

EAN 4000870 666326

**666.32 new**

**Hemisphere** A++-A

incl. 4×4,5 W LED

439 lm, 3000 K

230 V

⌀130 ⇄250 ⚙250 mm

EAN 4000870 666333

**666.33 new**



⚙ Matně bílý/Chrom 🗄 Kov/Akryl  
 ⚙ Biel matowa/Chrom 🗄 Metal/Akryl  
 ⚙ Белый матовый/Хром 🗄 Металл/Акрил



**Clear** A++-A

incl. 1×4,3 W  
409 lm, 3000 K  
230 V

⌀90 ⇄80 ⌀130 mm  
EAN 4000870 666623

**666.62 new**

LED 



**Clear** A++-A

incl. 2×4,3 W  
409 lm, 3000 K  
230 V

⌀140 ⇄305 ⌀80 mm  
EAN 4000870 666630

**666.63 new**

LED 



**Clear** A++-A

incl. 3×4,3 W  
409 lm, 3000 K  
230 V

⌀140 ⇄485 ⌀80 mm  
EAN 4000870 666647

**666.64 new**

LED 



**Clear** A++-A

incl. 4×4,3 W  
409 lm, 3000 K  
230 V

⌀150 ⇄785 ⌀90 mm  
EAN 4000870 666654

**666.65 new**

LED 



⚙ Nikl 🗄 Kov/Akryl  
 ⚙ Nikiel 🗄 Metal/Akryl  
 ⚙ Никель 🗄 Металл/Акрил





**Pole** A++-E

incl. 1×4,2 W  
499 lm, 3000 K  
230 V

⌀160 ⇄75 ⌀166 mm  
EAN 4000870 666548

**666.54 new**

LED   
On/Off 



**Pole** A++-E

incl. 2×4,2 W  
499 lm, 3000 K  
230 V

⌀171 ⇄310 ⌀75 mm  
EAN 4000870 666555

**666.55 new**

LED 



**Pole** A++-E

incl. 3×4,2 W  
499 lm, 3000 K  
230 V

⌀171 ⇄444 ⌀75 mm  
EAN 4000870 666562

**666.56 new**

LED 



**Pole** A++-E

incl. 4×4,2 W  
499 lm, 3000 K  
230 V

⌀171 ⇄282 ⌀282 mm  
EAN 4000870 666579

**666.57 new**

LED 



⚙ Białá/Chrom ⚪ Kov  
 ⚙ Biały/Chrom ⚪ Metal  
 ⚙ Белый/Хром ⚪ Металл



**Launcher** A++-A  
 incl. 1×4,5W  
 413 lm, 3000 K  
 230 V  
 ⚙140 ⇄80 ↗98 mm  
 EAN 4000870 666340  
**666.34 new**



**Launcher** A++-A  
 incl. 2×4,5W  
 413 lm, 3000 K  
 230 V  
 ⚙98 ⇄280 ↗80 mm  
 EAN 4000870 666357  
**666.35 new**



**Launcher** A++-A  
 incl. 3×4,5W  
 413 lm, 3000 K  
 230 V  
 ⚙98 ⇄430 ↗80 mm  
 EAN 4000870 666364  
**666.36 new**



**Launcher** A++-A  
 incl. 4×4,5W  
 413 lm, 3000 K  
 230 V  
 ⚙98 ⇄250 ↗250 mm  
 EAN 4000870 666371  
**666.37 new**



⚙ Białá/Chrom ⚪ Kov  
 ⚙ Biały/Chrom ⚪ Metal  
 ⚙ Белый/Хром ⚪ Металл

⚡ 282.99 3,5W  
 283.00 6,5W



**Zyli IP44** A++-E  
 max. 1×10W, GU10  
 230V  
 ø100 ↗110 mm  
 EAN 4000870 667101  
**667.10 new**



**Zyli IP44** A++-E  
 max. 2×10W, GU10  
 230V  
 ⚙110 ⇄400 ↗70 mm  
 EAN 4000870 667118  
**667.11 new**



**Zyli IP44** A++-E  
 max. 3×10W, GU10  
 230V  
 ⚙110 ⇄600 ↗70 mm  
 EAN 4000870 667132  
**667.13 new**



**Zyli IP44** A++-E  
 max. 3×10W, GU10  
 230V  
 ⚙110 ø250 mm  
 EAN 4000870 667125  
**667.12 new**



⚡ Bílá/Chrom 🗄 Kov  
 ⚡ Biały/Chrom 🗄 Metal  
 ⚡ Белый/Хром 🗄 Металл

💡 282.99 3,5W  
 283.00 6,5W



#### Drop IP44

max. 1×10W, GU10  
 230V  
 ⚡123 ⌀100 ↗165 mm  
 EAN 4000870 667149  
**667.14 new**

A++-E



#### Drop IP44

max. 2×10W, GU10  
 230V  
 ⚡165 ↔350 ↗65 mm  
 EAN 4000870 667156  
**667.15 new**

A++-E



#### Drop IP44

max. 3×10W, GU10  
 230V  
 ⚡165 ⌀250 mm  
 EAN 4000870 667163  
**667.16 new**

A++-E



⚡ Bílá/Chrom 🗄 Kov  
 ⚡ Biały/Chrom 🗄 Metal  
 ⚡ Белый/Хром 🗄 Металл

💡 282.99 3,5W  
 283.00 6,5W



#### Tube IP44

max. 1×10W, GU10  
 230V  
 ⚡138 ⌀100 ↗94 mm  
 EAN 4000870 667170  
**667.17 new**

A++-E



#### Tube IP44

max. 2×10W, GU10  
 230V  
 ⚡94 ↔350 ↗65 mm  
 EAN 4000870 667187  
**667.18 new**

A++-E



#### Tube IP44

max. 3×10W, GU10  
 230V  
 ⚡94 ⌀250 mm  
 EAN 4000870 667194  
**667.19 new**

A++-E





⚡ Bílá/Chrom 🗄 Kov/Plast  
 ⚡ Biały/Chrom 🗄 Metal/Tworzywo sztuczne  
 ⚡ Белый/Хром 🗄 Металл/Пластмасса

⚡ 284.34 5,7W ☉  
 283.00 6,5W

**Turn**

A++-E

max. 1×10W, GU10  
 230V  
 ⚡140 ⇄98 ↗150 mm  
 EAN 4000870 666746  
**666.74 new**

**Turn**

A++-E

max. 2×10W, GU10  
 230V  
 ⚡140 ⇄400 ↗98 mm  
 EAN 4000870 666753  
**666.75 new**

**Turn**

A++-E

max. 4×10W, GU10  
 230V  
 ⚡140 ⇄680 ↗98 mm  
 EAN 4000870 666760  
**666.76 new**



⚡ Černá/Chrom 🗄 Kov/Plast  
 ⚡ Czarny/Chrom  
 🗄 Metal/Tworzywo sztuczne  
 ⚡ черный/Хром 🗄 Металл/Пластмасса

⚡ 284.34 5,7W ☉  
 283.00 6,5W

**Turn**

A++-E

max. 1×10W, GU10  
 230V  
 ⚡140 ⇄98 ↗150 mm  
 EAN 4000870 666708  
**666.70 new**

**Turn**

A++-E

max. 2×10W, GU10  
 230V  
 ⚡140 ⇄400 ↗98 mm  
 EAN 4000870 666715  
**666.71 new**

**Turn**

A++-E

max. 4×10W, GU10  
 230V  
 ⚡140 ⇄680 ↗98 mm  
 EAN 4000870 666722  
**666.72 new**







⚡ Chrom Kov  
 ⚡ Chrom Metal  
 ⚡ Хром Металл

⚡ 284.34 5,7W   
 283.00 6,5W

**Rondo**

A++-E

max. 1×10W, GU10  
230V

$\updownarrow$ 105  $\leftrightarrow$ 100  $\curvearrowright$ 120 mm  
 EAN 4000870 666784

**666.78 new****Rondo**

A++-E

max. 2×10W, GU10  
230V

$\updownarrow$ 120  $\leftrightarrow$ 260  $\curvearrowright$ 75 mm  
 EAN 4000870 666791

**666.79 new****Rondo**

A++-E

max. 3×10W, GU10  
230V

$\updownarrow$ 120  $\leftrightarrow$ 420  $\curvearrowright$ 75 mm  
 EAN 4000870 666807

**666.80 new****Rondo**

A++-E

max. 4×10W, GU10  
230V

$\updownarrow$ 120  $\varnothing$ 220 mm  
 EAN 4000870 666814

**666.81 new**

⚡ Nikl satinovaný Kov  
 ⚡ Nikiel satynowy Metal  
 ⚡ Никель лощёный Металл

⚡ 284.34 5,7W   
 283.00 6,5W

**Meli**

A++-E

max. 1×10W, GU10  
230V

$\updownarrow$ 100  $\leftrightarrow$ 100  $\curvearrowright$ 160 mm  
 EAN 4000870 666869

**666.86 new****Meli**

A++-E

max. 2×10W, GU10  
230V

$\updownarrow$ 160  $\leftrightarrow$ 260  $\curvearrowright$ 55 mm  
 EAN 4000870 666876

**666.87 new****Meli**

A++-E

max. 3×10W, GU10  
230V

$\updownarrow$ 160  $\leftrightarrow$ 400  $\curvearrowright$ 55 mm  
 EAN 4000870 666883

**666.88 new****Meli**

A++-E

max. 4×10W, GU10  
230V

$\updownarrow$ 160  $\leftrightarrow$ 600  $\curvearrowright$ 55 mm  
 EAN 4000870 666890

**666.89 new**



⚡ Nikl satinovaný 📦 Kov  
 ⚡ Nikiel satynowy 📦 Metal  
 ⚡ Никель лощёный 📦 Металл

⚡ 284.10 5,3W  
 284.34 5,7W ☉



**Teja** ⚡ A++-E  
 max. 1×10W, GU10  
 230V  
 ⚡100 ⇄52 ↻120 mm  
 EAN 4000870 666982  
**666.98 new**



**Teja** ⚡ A++-E  
 max. 2×10W, GU10  
 230V  
 ⚡120 ⇄308 ↻52 mm  
 EAN 4000870 666999  
**666.99 new**



**Teja** ⚡ A++-E  
 max. 3×10W, GU10  
 230V  
 ⚡120 ⇄500 ↻52 mm  
 EAN 4000870 667002  
**667.00 new**



**Teja** ⚡ A++-E  
 max. 4×10W, GU10  
 230V  
 ⚡120 ⇄250 ↻250 mm  
 EAN 4000870 667019  
**667.01 new**



**Teja Flex** ⚡ A++-E  
 max. 1×10W, GU10  
 230V  
 ⚡100 ⇄52 ↻350 mm  
 EAN 4000870 666975  
**666.97 new**



⚡ Bílá 📦 Kov  
 ⚡ Biały 📦 Metal  
 ⚡ Белый 📦 Металл

⚡ 284.10 5,3W  
 284.34 5,7W ☉



**Teja** ⚡ A++-E  
 max. 1×10W, GU10  
 230V  
 ⚡100 ⇄52 ↻120 mm  
 EAN 4000870 667026  
**667.02 new**



**Teja** ⚡ A++-E  
 max. 2×10W, GU10  
 230V  
 ⚡120 ⇄308 ↻52 mm  
 EAN 4000870 667033  
**667.03 new**



**Teja** ⚡ A++-E  
 max. 3×10W, GU10  
 230V  
 ⚡120 ⇄500 ↻52 mm  
 EAN 4000870 667040  
**667.04 new**



**Teja** ⚡ A++-E  
 max. 4×10W, GU10  
 230V  
 ⚡120 ⇄250 ↻250 mm  
 EAN 4000870 667057  
**667.05 new**



⚙️ Nikl kartáčovaný 📏 Kov  
 ⚙️ Nikiel satynowane 📏 Metal  
 ⚙️ Никель, крацеванный 📏 Металл

💡 284.10 5,3W  
 284.34 5,7W Ⓞ



#### Georgia A++-E

max. 1×10W, GU10  
230V

⚙️ 125 ⇄ 55 ⇄ 75 mm  
 EAN 4000870 667064

**667.06 new**



#### Georgia A++-E

max. 2×10W, GU10  
230V

⚙️ 100 ⇄ 396 ⇄ 55 mm  
 EAN 4000870 667071

**667.07 new**



#### Georgia A++-E

max. 3×10W, GU10  
230V

⚙️ 100 ⇄ 600 ⇄ 55 mm  
 EAN 4000870 667088

**667.08 new**



#### Georgia A++-E

max. 4×10W, GU10  
230V

⚙️ 100 ⇄ 675 ⇄ 55 mm  
 EAN 4000870 667095

**667.09 new**



⚙️ Chrom 📏 Kov  
 ⚙️ Chrom 📏 Metal  
 ⚙️ Хром 📏 Металл

💡 284.34 5,7W  
 283.00 6,5W Ⓞ



#### Zylo A++-E

max. 1×10W, GU10  
230V

⚙️ 100 ⇄ 100 ⇄ 132 mm  
 EAN 4000870 666937

**666.93 new**



On/Off



#### Zylo A++-E

max. 2×10W, GU10  
230V

⚙️ 132 ⇄ 260 ⇄ 55 mm  
 EAN 4000870 666944

**666.94 new**



#### Zylo A++-E

max. 3×10W, GU10  
230V

⚙️ 132 ⇄ 400 ⇄ 55 mm  
 EAN 4000870 666951

**666.95 new**



#### Zylo A++-E

max. 4×10W, GU10  
230V

⚙️ 132 ⇄ 695 ⇄ 70 mm  
 EAN 4000870 666968

**666.96 new**





⌘ Matný chrom/Opál ⌘ Kov  
 ⌘ Chrom matowy/Opal ⌘ Metal/Glas  
 ⌘ Хром матовый/Опал ⌘ Металл/Глас

Ⓛ 284.34 5,7W Ⓞ  
 282.86 3,5W

**WolbaLED**

A++-E

max. 1×10W, GU10  
 230V  
 Ⓢ105 Ⓢ100 Ⓢ105 mm  
 EAN 4000870 666821

**666.82 new****WolbaLED**

A++-E

max. 2×10W, GU10  
 230V  
 Ⓢ105 Ⓢ275 Ⓢ60 mm  
 EAN 4000870 666838

**666.83 new****WolbaLED**

A++-E

max. 4×10W, GU10  
 230V  
 Ⓢ105 Ⓢ210 Ⓢ210 mm  
 EAN 4000870 666845

**666.84 new****WolbaLED**

A++-E

max. 6×10W, GU10  
 230V  
 Ⓢ170 Ⓢ1660 Ⓢ55 mm  
 EAN 4000870 666852

**666.85 new**

⌘ Chrom/Satén ⌘ Kov/Sklo  
 ⌘ Chrom/Satynowany ⌘ Metal/Szkło  
 ⌘ Хром/Сатин ⌘ Металл/Стекло

Ⓛ 284.46 3W

**Yasmin**

A++-E

max. 1×10W, G9  
 230V  
 ⌀80 Ⓢ155 mm  
 EAN 4000870 666906

**666.90 new****Yasmin**

A++-E

max. 3×10W, G9  
 230V  
 Ⓢ140 ⌀280 mm  
 EAN 4000870 666913

**666.91 new****Yasmin**

A++-E

max. 4×10W, G9  
 230V  
 Ⓢ145 Ⓢ715 Ⓢ100 mm  
 EAN 4000870 666920

**666.92 new**



⚙ Chrom ⚪ Kov  
 ⚙ Chrom ⚪ Metal  
 ⚙ Хром ⚪ Металл

💡 283.38 2,2W



#### Lagoon

A++-E

max. 1×10W, G9 incl. 1×5W  
230V

⌀104 ⇄100 ⚙104 mm

EAN 4000870 666463

**666.46 new**

LED



#### Lagoon

A++-E

max. 2×10W, G9 incl. 1×5W  
497 lm, 3000K

230V

⌀75 ⇄350 ⚙150 mm

EAN 4000870 666470

**666.47 new**

LED



#### Lagoon

A++-E

max. 3×10W, G9 incl. 1×5W  
497 lm, 3000K

230V

⌀75 ⇄845 ⚙155 mm

EAN 4000870 666487

**666.48 new**

LED



#### Lagoon

A++-E

max. 4×10W, G9 incl. 1×5W  
497 lm, 3000K

230V

⌀115 ⌀290 mm

EAN 4000870 666494

**666.49 new**

LED



⚙ Biała/Chrom ⚪ Kov  
 ⚙ Biały/Chrom ⚪ Metal  
 ⚙ Белый/Хром ⚪ Металл

💡 283.38 2,2W  
284.46 3W



#### LED Double

A++-E

incl. 1×2,2W, G9, A++

200 lm

230V

⌀108 ⇄100 ⚙100 mm

EAN 4000870 666180

**666.18 new**

LED



#### LED Double

A++-E

incl. 2×2,2W, G9, A++

200 lm

230V

⌀118 ⇄364 ⚙100 mm

EAN 4000870 666197

**666.19 new**

LED



#### LED Double

A++-E

incl. 3×2,2W, G9, A++

200 lm

230V

⌀118 ⇄604 ⚙100 mm

EAN 4000870 666203

**666.20 new**

LED



#### LED Double

A++-E

incl. 4×2,2W, G9, A++

200 lm

230V

⌀118 ⇄704 ⚙100 mm

EAN 4000870 666210

**666.21 new**

LED



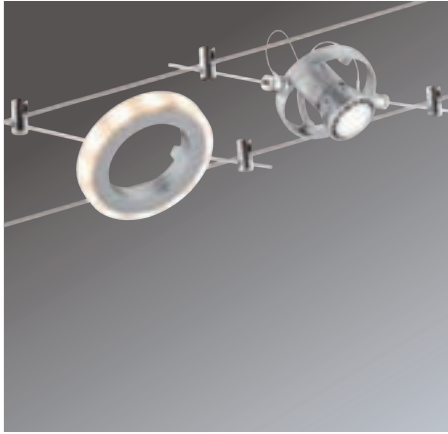

⚙️ Matný chrom 🏠 Kov  
 ⚙️ Chrom matowy 🏠 Metal  
 ⚙️ Хром матовый 🏠 Металл

230V  **12V**  AC

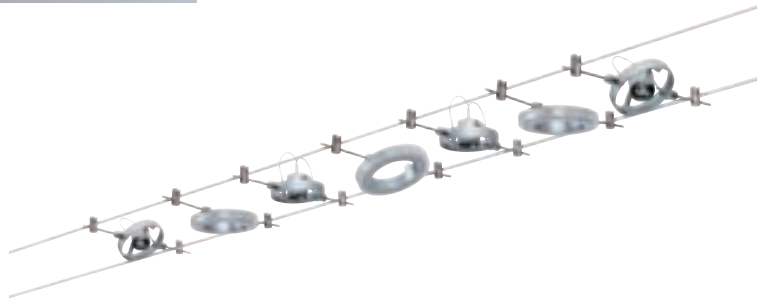

**Set HaloLED**

A++-E

incl. 3x1,5 W

LED

max. 4x10 W, GU4

230/12V, 80 VA

± 160 mm 2,5 mm<sup>2</sup> ↔ 12 m

EAN 4000870 941423

**941.42 new**

💡 282.60 4W



⚙️ Matný chrom 🏠 Kov/Plast  
 ⚙️ Chrom matowy 🏠 Metal/Tworzywo sztuczne  
 ⚙️ Хром матовый 🏠 Металл/Пластмасса

230V  **12V**  AC

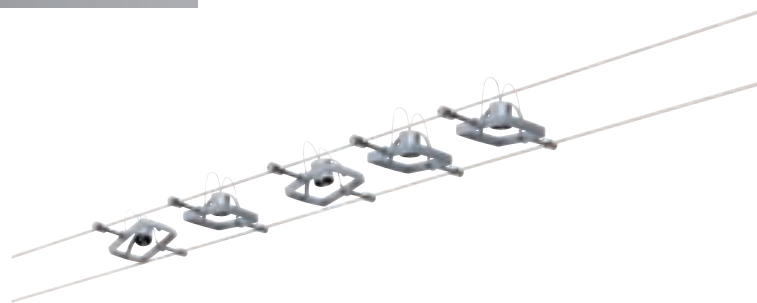

**Set Mac II**

A++-E

max. 5x10 W, GU5,3

230/12V, 60 VA

± 160 mm 2,5 mm<sup>2</sup> ↔ 10 m

EAN 4000870 941331

**941.33 new**

💡 283.47 7,5W





🛠️ Nikl satinovaný 🏠 Kov  
 🛠️ Nikiel satynowy 🏠 Metal  
 🛠️ Никель лощёный 🏠 Металл

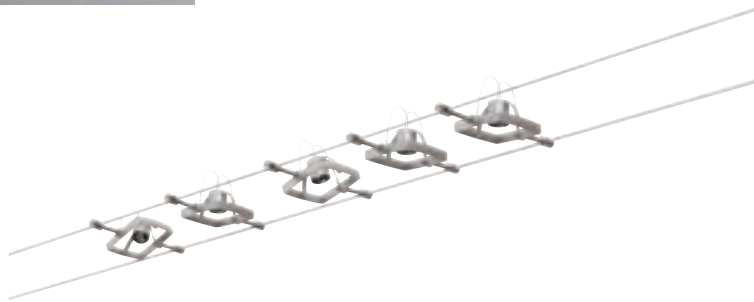

### Set Mac II A++-E

max. 5×10 W, GU5,3  
 230/12 V, 60 VA  
 ⚙️ 160 mm 2,5 mm<sup>2</sup> ↔ 10 m  
 EAN 4000870 941355  
**941.35 new**  
 ⚡ 283.47 7,5 W



🛠️ Biłá 🏠 Kov  
 🛠️ Biały 🏠 Metal  
 🛠️ Белый 🏠 Металл

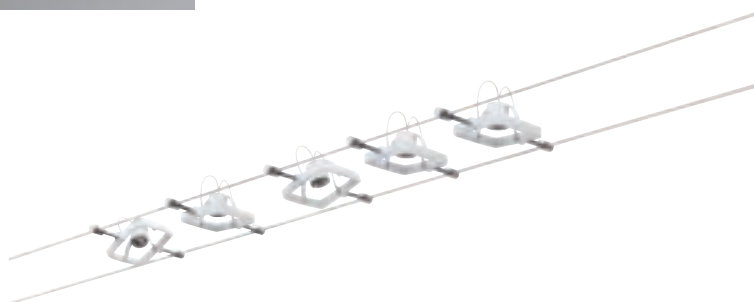

### Set Mac II A++-E

max. 5×10 W, GU5,3  
 230/12 V, 60 VA  
 ⚙️ 160 mm 2,5 mm<sup>2</sup> ↔ 10 m  
 EAN 4000870 941348  
**941.34 new**  
 ⚡ 283.47 7,5 W



🛠️ Matný chrom/Chrom 📦 Kov  
 🛠️ Chrom matowy/Chrom 📦 Metal  
 🛠️ Хром матовый/Хром 📦 Металл

230V  **12V**  AC



**Set Cardan** ◀ A++-E

max. 4x10W, GU5,3  
 230/12V, 80VA  
 ⚙️ 125 mm 2,5 mm<sup>2</sup> ↔ 10 m  
 EAN 4000870 941447  
**941.44 new**  
 ⚡ 283.47 7,5W



🛠️ Chrom 📦 Kov  
 🛠️ Chrom 📦 Metal  
 🛠️ Хром 📦 Металл

230V  **12V**  AC



**Set Togo** ◀ A++-E

max. 4x10W, GU5,3  
 230/12V, 80VA  
 ⚙️ 160 mm 4 mm<sup>2</sup> ↔ 10 m  
 EAN 4000870 941461  
**941.46 new**  
 ⚡ 283.30 3W



⚙️ Matný chrom 🏠 Kov  
 ⚙️ Chrom matowy 🏠 Metal  
 ⚙️ Хром матовый 🏠 Металл



### Set Spice Salt

A++-E

max. 5×10 W, GU5,3

230/12 V, 80 VA

⚙️ 160 mm 2,5 mm<sup>2</sup> ↔ 10 m

EAN 4000870 941454

**941.45 new**

⚙️ 283.47 7,5 W



⚙️ Matný chrom/Opál 🏠 Kov/Sklo  
 ⚙️ Chrom matowy/Opal  
 🏠 Metal/Szkło  
 ⚙️ Хром матовый/Опал  
 🏠 Металл/Стекло

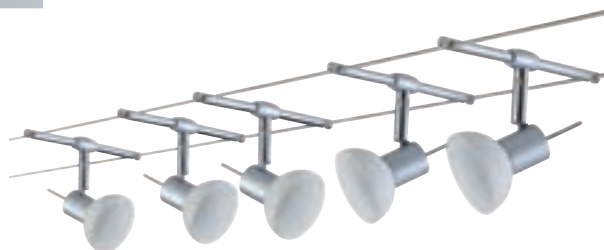

### Set Sheela

A++-E

max. 5×10 W, GU5,3

230/12 V, 60 VA

⚙️ 160 mm 2,5 mm<sup>2</sup> ↔ 10 m

EAN 4000870 941362

**941.36 new**

⚙️ 283.30 3 W



- 🔗 Chrom/Satén 📊 Kov/Sklo
- 🔗 Chrom/Satynowany
- 📊 Metal/Szkło
- 🔗 Хром/Сатин 📊 Металл/Стекло

230V  **12V** 



**Set Colmar** A++-E

max. 5×10W, GU4  
230/12V, 80VA  
⌀ 160 mm 2,5 mm<sup>2</sup> ↔ 10 m  
EAN 4000870 941430  
**941.43 new**  
🔗 283.29 1,8W

**Spot Fennel**

A++-E

max. 2×10W, G4

12V

⌀160 ⌀30 ⌀36 ⌀120 ⌀140 mm

EAN4000870 941409

**941.40 new**

⊙ 282.76 2,5W

⌘ Matný chrom/Satén ⌘ Kov/Sklo

⌘ Chrom matowy/Satynowany

⌘ Metal/Szkło

⌘ Хром матовый/Сатин ⌘ Металл/Стекло

**Spot Mac II**

A++-E

max. 1×10W, GU5,3

12V

⌀160 ⌀55 ⌀70 ⌀70 mm

EAN4000870 941324

**941.32 new**

⊙ 283.47 7,5W

⌘ Matný chrom ⌘ Kov/Plast

⌘ Chrom matowy

⌘ Metal/Tworzywo sztuczne

⌘ Хром матовый ⌘ Металл/Пластмасса

**Spot Cardan**

A++-E

max. 1×10W, GU5,3

12V

⌀125 ⌀100 ⌀110 mm

EAN4000870 941379

**941.37 new**

⊙ 283.47 7,5W

⌘ Matný chrom/Chrom ⌘ Kov

⌘ Chrom matowy/Chrom ⌘ Metal

⌘ Хром матовый/Хром ⌘ Металл

**Spot Togo**

A++-E

max. 1×10W, GU5,3

12V

⌀160 ⌀80 ⌀51 mm

EAN4000870 941478

**941.47 new**

⊙ 283.30 3W

⊙ 283.47 7,5W

⌘ Chrom ⌘ Kov

⌘ Chrom ⌘ Metal

⌘ Хром ⌘ Металл

**Spot Salt**

A++-E

max. 1×10W, GU5,3

12V

⌀160 ⌀30 ⌀115 ⌀51 ⌀64 mm

EAN4000870 941393

**941.39 new**

⊙ 283.47 7,5W

⌘ Matný chrom ⌘ Kov

⌘ Chrom matowy ⌘ Metal

⌘ Хром матовый ⌘ Металл

**Spot Sheela**

A++-E

max. 1×10W, GU5,3

12V

⌀160 ⌀30 ⌀120 ⌀65 ⌀95 mm

EAN4000870 941317

**941.31 new**

⊙ 283.30 3W

⌘ Matný chrom/Opál ⌘ Kov/Sklo

⌘ Chrom matowy/Opal ⌘ Metal/Szkło

⌘ Хром матовый/Опал ⌘ Металл/Стекло

**Spot Colmar**

A++-E

max. 1×10W, GU4

12V

⌀160 ⌀30 ⌀110 ⌀85 ⌀80 mm

EAN4000870 941386

**941.38 new**

⊙ 283.29 1,8W

⌘ Chrom/Satén ⌘ Kov/Sklo

⌘ Chrom/Satynowany ⌘ Metal/Szkło

⌘ Хром/Сатин ⌘ Металл/Стекло

*Nakombinujte si sami svůj osobní systém světel*  
*Stwórz sobie sam własny system oświetlenia*  
*Составьте сами собственную световую систему*

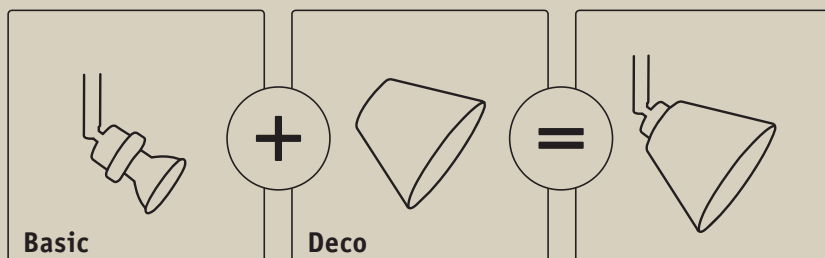
**Spot Basic**

A++-E

max. 1×10W, GU5,3

12V

↔160 ↔30 ↕130 ↔95 ↗75 mm

EAN4000870 941416

**941.41 new**

☉ 283.30 3W

☞ Matný chrom ☞ Kov

☞ Chrom matowy ☞ Metal

☞ Хром матовый ☞ Металл

**Tessa**

max. 50W

↕152 ø255 mm

EAN4000870 603246

**603.24**

☞ Modrá ☞ Materiál  
 ☞ Siný ☞ Fibryna  
 ☞ Синий ☞ Ткань

**Tessa**

max. 50W

↕152 ø255 mm

EAN4000870 603253

**603.25**

☞ Žlutá ☞ Materiál  
 ☞ Żółty ☞ Fibryna  
 ☞ Жёлтый ☞ Ткань

**Tessa**

max. 50W

↕152 ø255 mm

EAN4000870 603260

**603.26**

☞ Bílá ☞ Materiál  
 ☞ Biały ☞ Fibryna  
 ☞ Белый ☞ Ткань

**Tessa**

max. 50W

↕152 ø255 mm

EAN4000870 603277

**603.27**

☞ apricot ☞ Materiál  
 ☞ morelowy ☞ Fibryna  
 ☞ абрикосовый ☞ Ткань

**Rado**

max. 50W

↕95 ø70 mm

EAN4000870 953556

**953.55**

☞ Čirá ☞ Sklo  
 ☞ Przezroczysty ☞ Szkło  
 ☞ Прозрачный ☞ Стекло

**Turno**

max. 50W

↕90 ø80 mm

EAN4000870 953563

**953.56**

☞ Satén ☞ Sklo  
 ☞ Satynowany ☞ Szkło  
 ☞ Сатин ☞ Стекло

**Vico**

max. 50W

↕95 ø80 mm

EAN4000870 953570

**953.57**

☞ Čirá ☞ Sklo  
 ☞ Przezroczysty ☞ Szkło  
 ☞ Прозрачный ☞ Стекло

**Vento**

max. 50W

↕95 ø80 mm

EAN4000870 953587

**953.58**

☞ Satén ☞ Sklo  
 ☞ Satynowany ☞ Szkło  
 ☞ Сатин ☞ Стекло



**Vento**

max. 50 W  
 ⌀95 ø80 mm  
 EAN4000870 953594  
**953.59**

☞ Kouřové sklo ☐ Sklo  
 ☞ Szkło przydymione ☐ Szkło  
 ☞ Дымчатое стекло ☐ Стекло

**Wolbi**

max. 50 W  
 ⌀70 ø90 mm  
 EAN4000870 600559  
**600.55**

☞ Opál ☐ Sklo  
 ☞ Opal ☐ Szkło  
 ☞ Opal ☐ Стекло

**Quad**

max. 50 W  
 ⌀80 ø75 mm  
 EAN4000870 600153  
**600.15**

☞ Bílá ☐ Sklo  
 ☞ Biały ☐ Szkło  
 ☞ Белый ☐ Стекло

**Kegi**

max. 50 W  
 ⌀80 ø110 mm  
 EAN4000870 600122  
**600.12**

☞ Bílá ☐ Sklo  
 ☞ Biały ☐ Szkło  
 ☞ Белый ☐ Стекло

**Zyli**

max. 50 W  
 ⌀80 ø70 mm  
 EAN4000870 600047  
**600.04**

☞ Bílá ☐ Sklo  
 ☞ Biały ☐ Szkło  
 ☞ Белый ☐ Стекло

**Zyli**

max. 50 W  
 ⌀80 ø70 mm  
 EAN4000870 600535  
**600.53**

☞ Opál/Černá ☐ Sklo  
 ☞ Opal/Czarny ☐ Szkło  
 ☞ Opal/черный ☐ Стекло

**Zyli**

max. 50 W  
 ⌀80 ø70 mm  
 EAN4000870 600061  
**600.06**

☞ Hnědá ☐ Sklo  
 ☞ Brazowy ☐ Szkło  
 ☞ коричневый ☐ Стекло

**Wolbi**

max. 50 W  
 ⌀80 ø90 mm  
 EAN4000870 600078  
**600.07**

☞ Bílá ☐ Sklo  
 ☞ Biały ☐ Szkło  
 ☞ Белый ☐ Стекло

**Wolbi**

max. 50 W  
 ⌀80 ø90 mm  
 EAN4000870 600115  
**600.11**

☞ Dvoubarevná ☐ Sklo  
 ☞ Dichroiczne ☐ Szkło  
 ☞ Дихрочинный ☐ Стекло

**Wolbi**

max. 50 W  
 ⌀80 ø90 mm  
 EAN4000870 600085  
**600.08**

☞ Bílá ☐ Kov  
 ☞ Biały ☐ Metal  
 ☞ Белый ☐ Металл

**Wolbi**

max. 50 W  
 ⌀80 ø90 mm  
 EAN4000870 600092  
**600.09**

☞ Bílá/Hliník ☐ Kov  
 ☞ Biały/Alu ☐ Metal  
 ☞ Белый/Алюминий  
 ☐ Металл

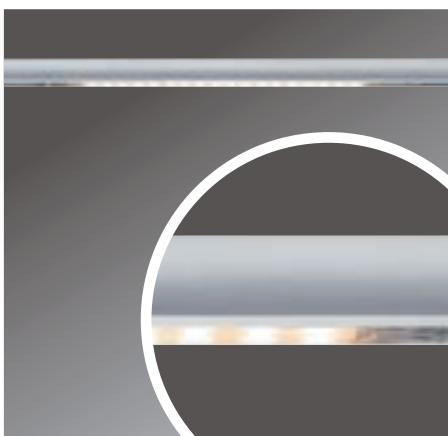

- 🔍 Průhledná 📦 Plast
- 🔍 Przezroczysty
- 📦 Tworzywo sztuczne
- 🔍 Прозрачный
- 📦 Пластмасса



#### Spot Inline Twenty

A++-A

incl. 1x2 W  
108 lm, 2700 K  
230 V  
⌀16 ⇄200 ↗8,5 mm  
EAN4000870 952917

**952.91** 📦 **new**

LED



#### Spot Inline Fourty

A++-A

incl. 1x3,3 W  
222 lm, 2700 K  
230 V  
⌀16 ⇄400 ↗8,5 mm  
EAN4000870 952924

**952.92** 📦 **new**

LED



#### Spot Inline Ninety

A++-A

incl. 1x5,2 W  
501 lm, 2700 K  
230 V  
⌀16 ⇄900 ↗8,5 mm  
EAN4000870 952931

**952.93** 📦 **new**

LED





CM

⚙️ Matný chrom/Chrom 📏 Kov  
 ⚙️ Chrom matowy 📏 Metal  
 ⚙️ Хром матовый 📏 Металл

💡 284.34 5,7W ☉

**Spot Barelli**

A++-E

max. 10W, GU10  
 230V  
 ⚙️138 ⚡68 ⚙️35 mm  
 EAN4000870 954614

**Starter Set Barelli**

A++-E

max. 3x10W, GU10  
 230V  
 ⚡1,2 m  
 EAN4000870 954591

**954.61 new**

CM

⚙️ Matný chrom/Chrom 📏 Kov  
 ⚙️ Chrom matowy/Chrom 📏 Metal  
 ⚙️ Хром матовый/Хром 📏 Металл

💡 283.45 8W ☉  
 283.00 6,5W

**Spot Pure I**

A++-E

max. 10W, GU10  
 230V  
 ⚙️110 ⚡58 ⚙️66 mm  
 EAN4000870 953297

**953.29 new**

CM

⚙️ Matný chrom/Chrom 📏 Kov  
 ⚙️ Chrom matowy/Chrom 📏 Metal  
 ⚙️ Хром матовый/Хром 📏 Металл

💡 283.45 8W  
 283.00 6,5W  
 284.34 5,7W ☉

**Spot Pure II**

A++-E

max. 10W, GU10  
 230V  
 ⚙️110 ⚡58 ⚙️66 mm  
 EAN4000870 953310

**953.31 new****Starter Set Pure II**

A++-E

max. 3x10W, GU10  
 230V  
 ⚡1,2 m  
 EAN4000870 954638

**954.63 new**

CM

⚙️ Matný chrom/Chrom 📏 Kov  
 ⚙️ Chrom matowy/Chrom 📏 Metal  
 ⚙️ Хром матовый/Хром 📏 Металл

💡 283.45 8W  
 283.00 6,5W  
 284.34 5,7W ☉

**Spot Cover**

A++-E

max. 10W, GU10  
 230V  
 ⚙️140 ⚡58 ⚙️90 mm  
 EAN4000870 953358

**953.35 new****Starter Set Cover**



A++-E

max. 3x10W, GU10  
 230V  
 ⚡1,2 m  
 EAN4000870 954621

**954.62 new**



CM

⌚ Matný chrom/Satén  Kov  
 ⌚ Chrom matowy/Satynowany  
 Metal/Glas  
 ⌚ Хром матовый/Сатин  
 Металл/Глас

⌚ 283.38 2,2W  
 284.46 3W 





Spot Blossom

A++-E

max. 10 W, G9  
 230 V  
 ⌚128 ⇔74 ↻115 mm  
 EAN4000870 953372  
**953.37 new**



CM

⌚ Matný chrom/Čirá/Satén  
 Kov/Sklo ⌚ Chrom matowy/  
 Przezroczysty/Satynowany  
 Metal/Szkło  
 ⌚ Хром матовый/Прозрачный/  
 Сатин  Металл/Стекло

⌚ 283.38 2,2W  
 284.46 3W 





Spot Blossom

A++-E

max. 10 W, G9  
 230 V  
 ⌚128 ⇔74 ↻115 mm  
 EAN4000870 953389  
**953.38 new**



CM

⌚ Matný chrom/Kouřové sklo  
 Kov/Sklo  
 ⌚ Chrom matowy/Szkło przydymione  
 Metal/Szkło  
 ⌚ Хром матовый/Дымчатое стекло  
 Металл/Стекло

⌚ 283.38 2,2W  
 284.46 3W 





Spot Blossom

A++-E

max. 10 W, G9  
 230 V  
 ⌚128 ⇔74 ↻115 mm  
 EAN4000870 953396  
**953.39 new**



CM

⌚ Matný chrom/Světle  
 fialová/Průhledná  Kov/Sklo  
 ⌚ Chrom matowy/Bez/  
 Przezroczysty  Metal/Szkło  
 ⌚ Хром матовый/Сирень/  
 Прозрачный  Металл/Стекло

⌚ 283.38 2,2W  
 284.46 3W 



Spot Blossom

A++-E

max. 10 W, G9  
 230 V  
 ⌚128 ⇔74 ↻115 mm  
 EAN4000870 953402  
**953.40 new**





CM

⚙ Matný chrom/Žlutá průhledná  
 ☒ Kov/Sklo ⚙ Chrom matový/Žlutý  
 transparentný ☒ Metal/Szkło  
 ⚙ Хром матовый/Жёлтый  
 прозрачный ☒ Металл/Стекло

⚪ 283.38 2,2W  
 284.46 3W ⚪



## Spot Blossom

A++-E

max. 10 W, G9  
 230 V  
 ⚙128 ⇄74 ⚙115 mm  
 EAN4000870 953419  
**953.41 new**



CM

⚙ Matný chrom/Dvoubarevná  
 ☒ Kov/Sklo  
 ⚙ Chrom matový/Dichroiczne  
 ☒ Metal/Szkło  
 ⚙ Хром матовый/Дихроичный  
 ☒ Металл/Стекло

⚪ 282.86 3,5W

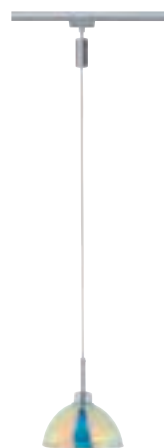

## Pendulum Sarrasani

A++-E

max. 10 W, GU10  
 230 V  
 ⚙135 cm ⌀140 mm  
 EAN4000870 954515  
**954.51 new**



CM

⚙ Matný chrom/Opál ☒ Kov/Sklo  
 ⚙ Chrom matový/Opal  
 ☒ Metal/Szkło  
 ⚙ Хром матовый/Опал  
 ☒ Металл/Стекло

⚪ 282.86 3,5W



## Pendulum Sarrasani

A++-E

max. 10 W, GU10  
 230 V  
 ⚙135 cm ⌀140 mm  
 EAN4000870 954508  
**954.50 new**

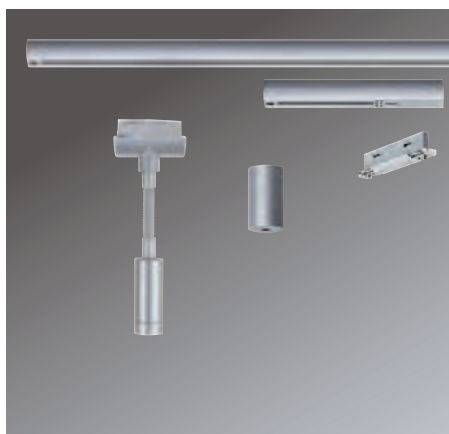

CM

⚙ Matný chrom  
 ☒ Kov

Starter Set Allround  
Pendant Basic

A++-E

max. 20 W  
 230 V  
 ⇄1,2 m  
 EAN4000870 954645  
**954.64 new**

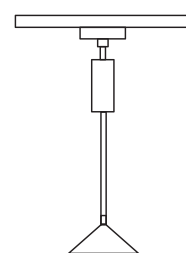

max. 1,5 kg

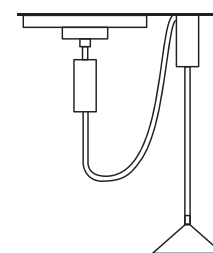

max. 3 kg



**W**  
 Bílá/Chrom Kov  
 Biały/Chrom Metal  
 Белый/Хром Металл

283.00 6,5W  
 283.45 8W



**Spot Cone**  
 max. 10 W, GU10  
 230 V  
 ∅180 ∅85 ∅90 mm  
 EAN4000870 953624  
**953.62 new**



**W**  
 Bílá/Chrom Kov  
 Biały/Chrom Metal  
 Белый/Хром Металл

283.00 6,5W  
 283.45 8W



**Spot Pipe**  
 max. 10 W, GU10  
 230 V  
 ∅150 ∅65 ∅100 mm  
 EAN4000870 953631  
**953.63 new**



**W**  
 Bílá/Chrom Kov  
 Biały/Chrom Metal  
 Белый/Хром Металл

283.00 6,5W  
 283.45 8W



**Spot Pure I**  
 max. 10 W, GU10  
 230 V  
 ∅110 ∅58 ∅66 mm  
 EAN4000870 953303  
**953.30 new**



**W**  
 Bílá/Chrom Kov  
 Biały/Chrom Metal  
 Белый/Хром Металл

283.00 6,5W  
 283.45 8W



**Spot Pure II**  
 max. 10 W, GU10  
 230 V  
 ∅110 ∅58 ∅66 mm  
 EAN4000870 953334  
**953.33 new**







W

- 🔧 Bílá/Chrom 📦 Kov
- 🔧 Biały/Chrom 📦 Metal
- 🔧 Белый/Хром 📦 Металл

💡 283.00 6,5W  
283.45 8W ☉

**Spot Cover**

A++-E

max. 10 W, GU10  
230 V  
⌀140 ⇄58 ↻90 mm  
EAN4000870 953365  
**953.36 new**



W

- 🔧 Bílá/Satén 📦 Kov/Sklo
- 🔧 Biały/Satynowany 📦 Metal/Szkło
- 🔧 Белый/Сатин 📦 Металл/Стекло

💡 283.38 2,2W  
284.46 3W ☉

**Spot Blossom**

A++-E

max. 10 W, G9  
230 V  
⌀128 ⇄74 ↻115 mm  
EAN4000870 953426  
**953.42 new**



W

- 🔧 Bílá/Čirá/Satén 📦 Kov/Sklo
- 🔧 Przezroczysty/Satynowany/Biały 📦 Metal/Szkło
- 🔧 Белый/Прозрачный/Сатин 📦 Металл/Стекло

💡 283.38 2,2W  
284.46 3W ☉

**Spot Blossom**

A++-E

max. 10 W, G9  
230 V  
⌀128 ⇄74 ↻115 mm  
EAN4000870 953433  
**953.43 new**



W

- 🔧 Bílá/Šedá průhledná 📦 Kov/Sklo
- 🔧 Biały/Szary transparentny 📦 Metal/Szkło
- 🔧 Белый/Серый прозрачный 📦 Металл/Стекло

💡 283.38 2,2W  
284.46 3W ☉

**Spot Blossom**

A++-E

max. 10 W, G9  
230 V  
⌀128 ⇄74 ↻115 mm  
EAN4000870 953440  
**953.44 new**





W

⚡ Bílá/Světle fialová/Průhledná  
 📏 Kov/Sklo  
 ⚡ Biały/Bez/Przezroczysty  
 📏 Metal/Szkło  
 ⚡ Белый/Сирень/Прозрачный  
 📏 Металл/Стекло

⚡ 283.38 2,2W  
 284.46 3W



**Spot Blossom**

A++-E

max. 10 W, G9  
 230 V  
 ⚡128 ⇄74 ↻115 mm  
 EAN4000870 953457  
**953.45 new**



W

⚡ Bílá/Žlutá průhledná 📏 Kov/Sklo  
 ⚡ Biały/Żółty transparentny  
 📏 Metal/Szkło  
 ⚡ Белый/Жёлтый прозрачный  
 📏 Металл/Стекло

⚡ 283.38 2,2W  
 284.46 3W



**Spot Blossom**

A++-E

max. 10 W, G9  
 230 V  
 ⚡128 ⇄74 ↻115 mm  
 EAN4000870 953464  
**953.46 new**



- ▶ Umožňuje ovládat jednotlivé zdroje (žárovky) a sdružené obvody tak, že lze spínat různé světelné scénáře (jako u 2fázového kolejničového systému)
- ▶ Všechny skupiny lze spínat dálkovým ovladačem
- ▶ Filigránové pouzdro pro bezdrátovou elektroniku
- ▶ Max. 50 W na jeden adaptér, vhodné i pro halogenová svítidla

- ▶ Umożliwia sterowanie pracą pojedynczych głowic i grup, a tym samym załączanie różnych układów oświetleniowych (jak w przypadku 2-fazowych systemów szynowych)
- ▶ Wszystkie grupy sterowanie zdalnie
- ▶ Filigranowa obudowa układu radiowego
- ▶ Maks. 50 W na adapter, odpowiednie również do lamp halogenowych

- ▶ Обеспечивает управление отдельными головками и групповыми схемами, что позволяет активировать различные сценарии освещения (как в 2-фазной системе шин)
- ▶ Переключение всех групп с помощью дистанционного управления
- ▶ Изящный корпус радиоэлектроники
- ▶ Макс. 50 Вт на каждый адаптер, подходит также для галогенных ламп



CM

- ↳ Matný chrom
- ↳ Chrom matowy
- ↳ Хром матовый

W

- ↳ Bílá
- ↳ Biały
- ↳ Белый

CM

- ↳ Matný chrom
- ↳ Chrom matowy
- ↳ Хром матовый

#### Wireless Adapter

max. 50 W  
230 V  
⌀50 ⇄166 ⚙19 mm

EAN4000870 952948  
**952.94** new

EAN4000870 952955  
**952.95** new



#### Remote for Wireless Adapter

EAN4000870 952962  
**952.96** new

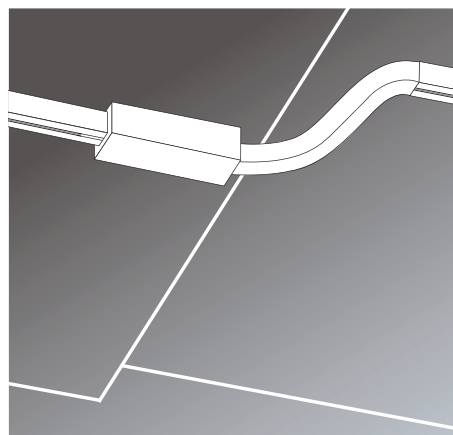

CM

- ↳ Matný chrom Kov
- ↳ Chrom matowy Metal
- ↳ Хром матовый Металл

W

- ↳ Bílá Kov
- ↳ Biały Metal
- ↳ Белый Металл

#### Spojka Maxiflex Łącznik Maxiflex Соединитель Maxiflex

max. 1000 W  
230 V  
⌀18 ⇄440 ⚙18 mm  
EAN4000870 953273  
**953.27** new



max. 1000 W  
230 V  
⌀18 ⇄440 ⚙18 mm  
EAN4000870 953280  
**953.28** new

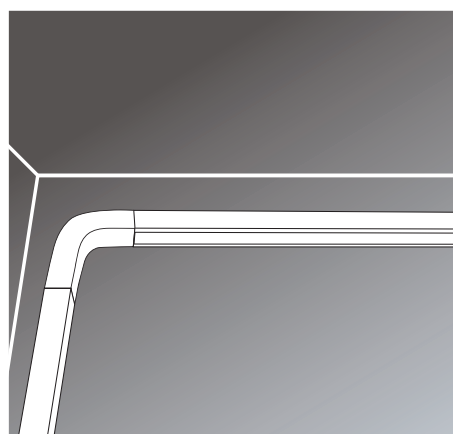

CM

- ↳ Matný chrom Kov
- ↳ Chrom matowy Metal
- ↳ Хром матовый Металл

W

- ↳ Bílá Kov
- ↳ Biały Metal
- ↳ Белый Металл

#### Flex Conector II

max. 1000 W  
230 V  
⌀18 ⇄227 ⚙18 mm  
EAN4000870 953259  
**953.25** new



max. 1000 W  
230 V  
⌀18 ⇄227 ⚙18 mm  
EAN4000870 953266  
**953.26** new





- 🔗 Stříbrná 📦 Plast
- 🔗 Srebrny 📦 Tworzywo sztuczne
- 🔗 Серебро 📦 Пластмасса



**Basic Set Warm white 1,5m expanded max. 3m Dimm/Switch Controller IR**

A++-A

incl. 1x10 W  
825 lm, 2700 K  
230/24 V, 20 VA  
⌀4 mm ↗12,5 mm ↔1,5 m  
EAN4000870 708026  
**708.02** 📦 **new**

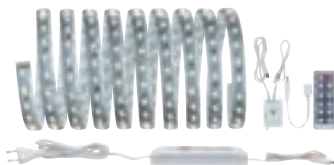

**Basic Set Warm white 3m expanded max. 5,4m Dimm/Switch Controller IR**

A++-A

incl. 1x20 W  
1650 lm, 2700 K  
230/24 V, 36 VA  
⌀4 mm ↗12,5 mm ↔3 m  
EAN4000870 708033  
**708.03** 📦 **new**



- 🔗 Stříbrná 📦 Plast
- 🔗 Srebrny 📦 Tworzywo sztuczne
- 🔗 Серебро 📦 Пластмасса



**Basic Set Warm white 1,5m expanded max. 4,2m Dimm/Switch Controller IR**

A++-A

incl. 1x20 W  
1650 lm, 2700 K  
230/24 V, 60 VA  
⌀4 mm ↗12,5 mm ↔1,5 m  
EAN4000870 708002  
**708.00** 📦 **new**



**Basic Set Warm white 3m expanded max. 5,3m Dimm/Switch Controller IR**

A++-A

incl. 1x40 W  
3300 lm, 2700 K  
230/24 V, 75 VA  
⌀4 mm ↗12,5 mm ↔3 m  
EAN4000870 708019  
**708.01** 📦 **new**



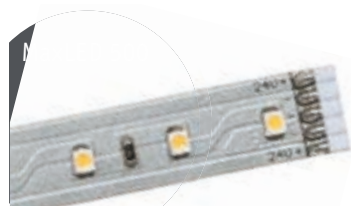

- 🔗 Stříbrná 📦 Plast
- 🔗 Srebrny 📦 Tworzywo sztuczne
- 🔗 Серебро 📦 Пластмасса

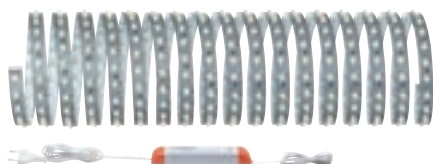

#### MaxLED Basic Sets

A++-A

incl. 1x70 W  
5500 lm, 2700 K  
230/24 V, 80 VA  
⌀4 mm ⌀12,5 mm ⇔10 m  
EAN4000870 708293  
**708.29** 📦 **new**



#### Strip Warm white 2,5m

A++-A

incl. 1x17,5 W  
1375 lm, 2700 K  
24 V  
⌀4 ⇔2500 ⌀12,5 mm  
EAN4000870 708279  
**708.27** 📦 **new**

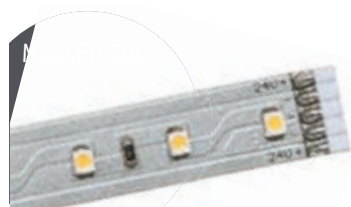

- 🔗 Stříbrná 📦 Plast
- 🔗 Srebrny 📦 Tworzywo sztuczne
- 🔗 Серебро 📦 Пластмасса



#### MaxLED Basic Sets

A++-A

incl. 1x60 W  
5500 lm, 6500 K  
230/24 V, 75 VA  
⌀4 mm ⌀12,5 mm ⇔10 m  
EAN4000870 708309  
**708.30** 📦 **new**



#### Strip Daylight 2,5m

A++-A

incl. 1x15 W  
1375 lm, 6500 K  
24 V  
⌀4 ⇔2500 ⌀12,5 mm  
EAN4000870 708286  
**708.28** 📦 **new**





IR-Sensor  
for YouLED Strip

- 🔧 Bílá 📦 Plast
- 🔧 Biały 📦 Tworzywo sztuczne
- 🔧 Белый 📦 Пластмасса



**IR-Sensor**

max. 60 W  
DC 12 V  
⌀18 ⇄36 ⚡36 mm  
EAN4000870 707265  
**707.26** 📦 **new**



On/Off Switch  
for YouLED Strip

- 🔧 Bílá 📦 Plast
- 🔧 Biały 📦 Tworzywo sztuczne
- 🔧 Белый 📦 Пластмасса



**On/Off Switch**

max. 60 W  
DC 12 V  
⌀15 ⇄60 ⚡26 mm  
EAN4000870 707272  
**707.27** 📦 **new**



for LED Strip

- 🔧 Hliník/Satén 📦 Hliník/Plast
- 🔧 Alu/Satynowany 📦 Alu/Tworzywo sztuczne
- 🔧 Алюминий/Сатин 📦 Алюминий/Пластмасса

**Square Profil incl. Diffusor 1m**

⌀15 ⇄1000 ⚡23 mm  
EAN4000870 708095  
**708.09** 📦 **new**



**Square Profil incl. Diffusor 2m**

⌀15 ⇄2000 ⚡23 mm  
EAN4000870 708101  
**708.10** 📦 **new**





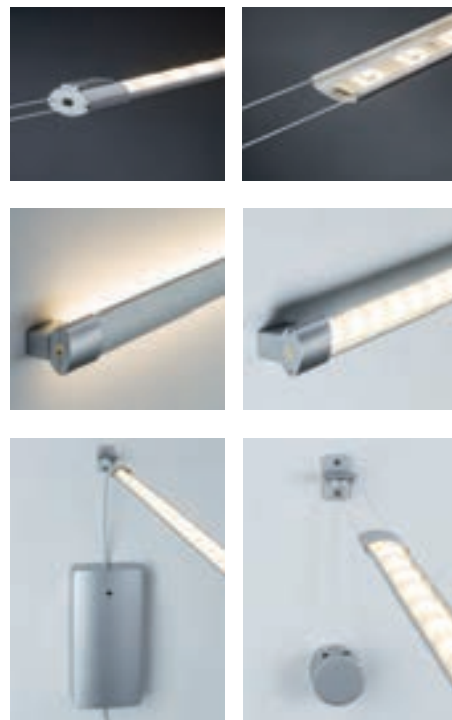

- ⌘ Hliník eloxovaný/Satén
- ⌘ Hliník/Plast
- ⌘ Alu anodowane/Satynowany
- ⌘ Alu/Tworzywo sztuczne
- ⌘ Анодированный алюминий/Сатин
- ⌘ Алюминий/Пластмасса

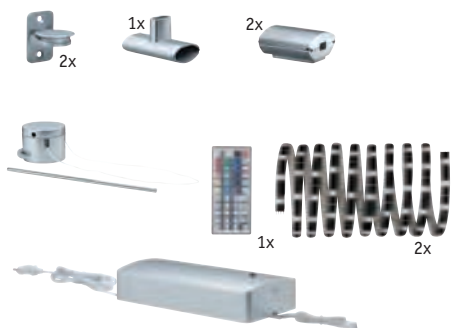

**Flying Strip Set** A++-A

incl. 1x26,5 W  
 1680 lm  
 <math>\sphericalangle 120^\circ</math>  
 230/12 V, 48 VA  
 ⌀25 mm ⌀3 mm ⌀10,5 mm ⇔6 m  
 EAN4000870 707173  
**707.17** **new**

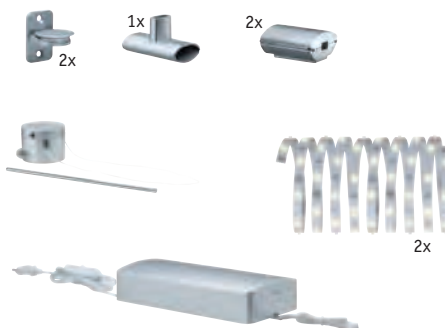

**Flying Strip Set** A++-A

incl. 1x14 W  
 1200 lm, 3000 K  
 <math>\sphericalangle 120^\circ</math>  
 230/12 V, 15 VA  
 ⌀25 mm ⌀3 mm ⌀10,5 mm ⇔6 m  
 EAN4000870 707166  
**707.16** **new**



**Flying Profil**

⌀25 mm ⌀11 mm ⇔2000 mm ⌀28 mm  
 EAN4000870 707159  
**707.15** **new**





**Wall-mounted Flying Profil**

⌀25 mm ⌀33 mm ⇔30 mm ⌀35 mm  
 EAN4000870 707197  
**707.19** **new**



**Flying Profil Diverter**

⌀25 mm ⌀43 mm ⇔27 mm ⌀37 mm  
 EAN4000870 707180  
**707.18** **new**

Satén/Bílá  Hliník/Sklo  
 Satynowany/Biały  Alu/Szkło  
 Сатин/Белый  Алюминий/Стекло

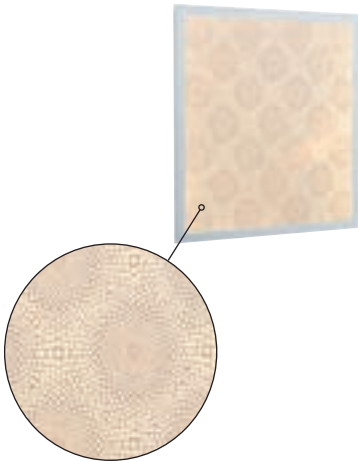

**Lumix** A++-A





incl. 1x11,5W  
 2000 lm, 2700 K  
 230/24 V, 36 VA  
 ⚡500 ↔500 ↗10 mm  
 EAN4000870 708132  
**708.13**  **new**

  
  
  
  



**Lumix** A++-A



incl. 1x11,5W  
 2000 lm, 2700 K  
 24 V  
 ⚡500 ↔500 ↗10 mm  
 EAN4000870 708149  
**708.14**  **new**

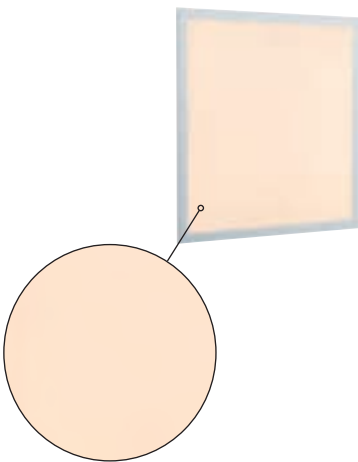

**Lumix** A++-A





incl. 1x11,5W  
 2000 lm, 2700 K  
 230/24 V, 36 VA  
 ⚡500 ↔500 ↗10 mm  
 EAN4000870 708118  
**708.11**  **new**



**Lumix** A++-A

incl. 1x11,5W  
 2000 lm, 2700 K  
 24 V  
 ⚡500 ↔500 ↗10 mm  
 EAN4000870 708125  
**708.12**  **new**



- 🔗 Білі/Сатэн 📦 Ков/Пласт
- 🔗 Biały/Satynowany
- 📦 Metal/Tworzywo sztuczne
- 🔗 Белый/Сатин 📦 Металл/Пластмасса



**Ace LED Panel** A++-A

incl. 1x7,5 W  
580 lm, 2700 K  
230/24 V, 24 VA  
⌀100 mm ⇔300 mm ⚙7 mm  
EAN4000870 707760  
**707.76** 📦 **new**

- LED
- 🔗
- 📦
- 🔗
- 📦
- ⚡

**Ace LED Panel** A++-A

incl. 1x7,5 W  
580 lm, 2700 K  
DC 24 V  
⌀100 mm ⇔300 mm ⚙7 mm  
EAN4000870 707777  
**707.77** 📦 **new**

- LED
- 🔗
- 📦
- 🔗
- 📦
- ⚡

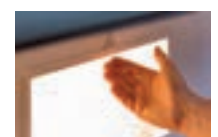

- 🔗 Білі/Сатэн 📦 Ков/Пласт
- 🔗 Biały/Satynowany
- 📦 Metal/Tworzywo sztuczne
- 🔗 Белый/Сатин 📦 Металл/Пластмасса



**Glow Basic** A++-A

incl. 1x8,0 W  
650 lm, 2700 K  
230/24 V, 24 VA  
⌀250 ⇔400 ⚙7 mm  
EAN4000870 708071  
**708.07** 📦 **new**

- LED
- 🔗
- 📦
- 🔗
- 📦
- ⚡

**Glow Extension** A++-A

incl. 1x8,0 W  
650 lm, 2700 K  
DC 24 V  
⌀250 ⇔400 ⚙7 mm  
EAN4000870 708088  
**708.08** 📦 **new**

- LED
- 🔗
- 📦
- 🔗
- 📦
- ⚡





► Úhel vyzařování 40–120°, variabilně nastavitelný sklápěcím mechanismem

► Kąt rozsyłu światła 40-120° regulowany za pomocą mechanizmu klapkowego

► Угол излучения регулируется в диапазоне 40-120° благодаря складному механизму



Šedá Hliník  
Szary Alu  
Серый Алюминий

∠ 40-120°

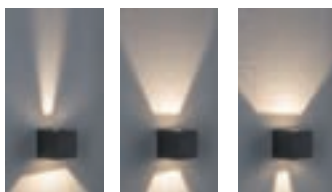

#### Special Line Cybo

incl. 2×3W  
2×355 lm, 2700 K  
40-120°  
230V  
∅80 ⇄80 ↗80 mm  
EAN 4000870 180006  
**180.00 new**

A++-A

LED

IP65



► Úhel vyzařování 40–120°, variabilně nastavitelný sklápěcím mechanismem

► Kąt rozsyłu światła 40-120° regulowany za pomocą mechanizmu klapkowego

► Угол излучения регулируется в диапазоне 40-120° благодаря складному механизму



Bílá Hliník  
Biały Alu  
Белый Алюминий

∠ 40-120°

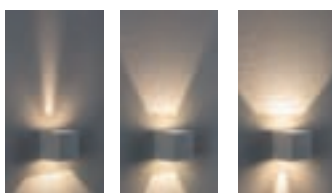

#### Special Line Cybo

incl. 2×3W  
2×355 lm, 2700 K  
40-120°  
230V  
∅80 ⇄80 ↗80 mm  
EAN 4000870 180013  
**180.01 new**

A++-A

LED

IP65



Šedá Hliník  
Szary Alu  
Серый Алюминий



#### Special Line Cybo

incl. 2×3W  
2×355 lm, 2700 K  
∠ 85°  
230V  
∅93 ⇄100 ↗100 mm  
EAN 4000870 180020  
**180.02 new**

A++-A

LED

IP65



Bílá Hliník  
Biały Alu  
Белый Алюминий



#### Special Line Cybo

incl. 2×3W  
2×355 lm, 2700 K  
∠ 85°  
230V  
∅93 ⇄100 ↗100 mm  
EAN 4000870 180037  
**180.03 new**

A++-A

LED

IP65



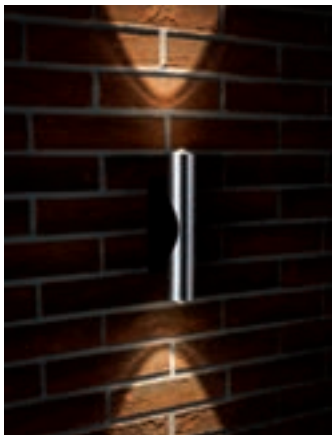

- ↳ Černá/Hliník kartáčovaný ▣ Hliník zinek
- ↳ Czarny/Alu satynowane ▣ Aluminium Cynk
- ↳ черный/Алюминий брашированный
- ▣ Алюминий Цинк



**Special Line 2Flame**

incl. 2×3,2W  
 2×360 lm, 2700 K  
 ∠ 45°, 460 cd  
 230V  
 ∅240 ⇔55 ∅80 mm  
 EAN 4000870 180044

**180.04 new**



- ↳ Černá/Hliník kartáčovaný ▣ Hliník zinek
- ↳ Czarny/Alu satynowane ▣ Aluminium Cynk
- ↳ черный/Алюминий брашированный
- ▣ Алюминий Цинк



**Special Line 2Flame**

incl. 2×3,2W  
 2×360 lm, 2700 K  
 ∠ 45°, 460 cd  
 230V  
 ∅210 ⇔120 ∅115 mm  
 EAN 4000870 180051

**180.05 new**



- ↳ Černá/Hliník kartáčovaný ▣ Hliník zinek
- ↳ Czarny/Alu satynowane ▣ Aluminium Cynk
- ↳ черный/Алюминий брашированный
- ▣ Алюминий Цинк



**Special Line 1Flame**

incl. 1×3,2W  
 360 lm, 2700 K  
 ∠ 45°, 460 cd  
 230V  
 ∅170 ⇔120 ∅115 mm  
 EAN 4000870 180068

**180.06 new**



- ↳ Matně bílý ▣ Hliník
- ↳ Biel matowa ▣ Alu
- ↳ Белый матовый
- ▣ Алюминий



**Special Line Big Flame**

incl. 1×5W  
 436 lm, 2700 K  
 ∠ 60°  
 230V  
 ∅103 ∅103 ⇔103 ∅143 mm  
 EAN 4000870 180075

**180.07 new**







⚡ Kartáčované železo 📦 Hliník  
 ⚡ Żelazo szorstkowane 📦 Alu  
 ⚡ Железо шероховатое 📦 Алюминий

💡 282.99



### Special Line Flame

A++-E

incl. 1×3,5W, GU10, <math>\langle A^+ \rangle</math>

230lm

<math>\sphericalangle 38^\circ</math>, 550cd

230V

⌀125 ⌀60 ↔70 ↗95mm

EAN 4000870 180082

**180.08 new**

LED

IP44

rost  
fret

⊗



⚡ Kartáčované železo 📦 Hliník  
 ⚡ Żelazo szorstkowane 📦 Alu  
 ⚡ Железо шероховатое 📦 Алюминий

💡 282.99



### Special Line Flame

A++-E

incl. 2×3,5W, GU10, <math>\langle A^+ \rangle</math>

2×230lm

<math>\sphericalangle 38^\circ</math>, 550cd

230V

⌀210 ⌀60 ↔70 ↗95mm

EAN 4000870 180099

**180.09 new**

LED

IP44

rost  
fret

⊗



⚡ Černá 📦 Plast  
 ⚡ Czarny 📦 Tworzywo sztuczne  
 ⚡ черный 📦 Пластмасса



### Special Line Junction-Box

max. 2500W

⌀134 ↔105 ↗53mm

EAN 4000870 002377

**237 new**

IP68



#### Premium LED 230V Slim Coin 51mm

- ▶ Malá minimální zápustná
- ▶ Vč. přípojovací krabice s dvojitou rychloupínací svorkou k připojení prosmyčkováním
- ▶ Niewielka głębokość montażu
- ▶ Ze szkłem
- ▶ Zawiera skrzynkę przyłączeniową z podwójną kostką zaciskową do łączenia równoległego
- ▶ Малая монтажная глубина
- ▶ С защитным стеклом
- ▶ Вкл. клеммовую коробку с двойным быстродействующим зажимом для сквозного шлейфования

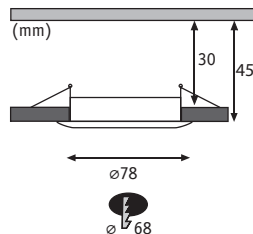

938.84

**Premium LED 230V Slim Coin Satin 51mm** Hliník zinek Aluminium Cynk Алюминий Цинк



☞ Matně bílý Biel matowa Белый матовый

**incl. 1×6,8 W** <A++-A> **incl. 3×6,8 W** <A++-A>  
592 lm, 2700 K 3× 592 lm, 2700 K

EAN4000870 938577  
**938.57 new**

EAN4000870 938584  
**938.58 new**



☞ Hliník soustružený tłoczzone aluminium aluminiowa spirala

**incl. 1×6,8 W** <A++-A> **incl. 3×6,8 W** <A++-A>  
592 lm, 2700 K 3× 592 lm, 2700 K

EAN4000870 938966  
**938.96 new**

EAN4000870 938973  
**938.97 new**



☞ Kartáčované železo Żelazo szcztokowane Железо шероховатое

**incl. 1×6,8 W** <A++-A> **incl. 3×6,8 W** <A++-A>  
592 lm, 2700 K 3× 592 lm, 2700 K

EAN4000870 938591  
**938.59 new**

EAN4000870 938607  
**938.60 new**



☞ Chrom Chrom Хром

**incl. 1×6,8 W** <A++-A> **incl. 3×6,8 W** <A++-A>  
592 lm, 2700 K 3× 592 lm, 2700 K

EAN4000870 938614  
**938.61 new**

EAN4000870 938621  
**938.62 new**

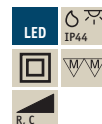
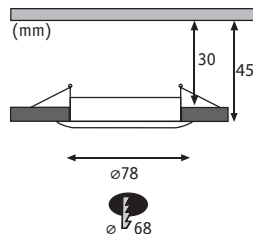

**Premium LED 230V Slim Coin Satin 51mm** Hliník zinek Aluminium Cynk Алюминий Цинк



☞ Matně bílý Biel matowa Белый матовый

**incl. 1×6,8 W** <A++-A  
633 lm, 2700 K

**incl. 3×6,8 W** <A++-A  
3× 633 lm, 2700 K

EAN4000870 938690  
**938.69 new**

EAN4000870 938706  
**938.70 new**



☞ Hliník soustružený tłoczone aluminium aluminiowa spirala

**incl. 1×6,8 W** <A++-A  
633 lm, 2700 K

**incl. 3×6,8 W** <A++-A  
3× 633 lm, 2700 K

EAN4000870 939000  
**939.00 new**

EAN4000870 939017  
**939.01 new**



☞ Kartáčované železo Żelazo szcztokowane Железо шероховатое

**incl. 1×6,8 W** <A++-A  
633 lm, 2700 K

**incl. 3×6,8 W** <A++-A  
3× 633 lm, 2700 K

EAN4000870 938713  
**938.71 new**

EAN4000870 938737  
**938.73 new**



☞ Chrom Chrom Хром

**incl. 1×6,8 W** <A++-A  
633 lm, 2700 K

**incl. 3×6,8 W** <A++-A  
3× 633 lm, 2700 K

EAN4000870 938720  
**938.72 new**

EAN4000870 938744  
**938.74 new**

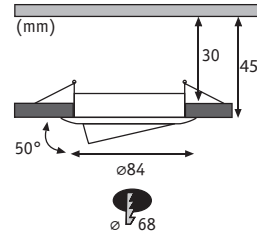

938.84

**Premium LED 230V Slim Coin Satin 51mm**

Hliník zinek Aluminium Cynk Алюминий Цинк



☞ Matně bílý Biel matowa Белый матовый

**incl. 1×6,8 W**

◀ A++-A

592 lm, 2700 K

**incl. 3×6,8 W**

◀ A++-A

3× 592 lm, 2700 K

EAN4000870 938638

**938.63 new**

EAN4000870 938645

**938.64 new**



☞ Hliník soustružený tłoczony aluminium aluminiowa spirala

**incl. 1×6,8 W**

◀ A++-A

592 lm, 2700 K

**incl. 3×6,8 W**

◀ A++-A

3× 592 lm, 2700 K

EAN4000870 938980

**938.98 new**

EAN4000870 938997

**938.99 new**



☞ Kartáčované železo Żelazo szcztokowane Железо шероховатое

**incl. 1×6,8 W**

◀ A++-A

592 lm, 2700 K

**incl. 3×6,8 W**

◀ A++-A

3× 592 lm, 2700 K

EAN4000870 938669

**938.66 new**

EAN4000870 938652

**938.65 new**



☞ Chrom Chrom Хром

**incl. 1×6,8 W**

◀ A++-A

592 lm, 2700 K

**incl. 3×6,8 W**

◀ A++-A

3× 592 lm, 2700 K

EAN4000870 938676

**938.67 new**

EAN4000870 938683

**938.68 new**

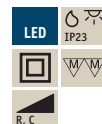
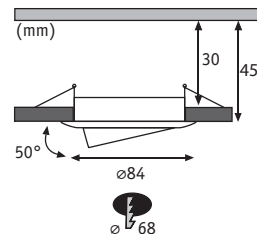

Hliník zinek Aluminium Cynk Алюминий Цинк



☞ Matně bílý Biel matowa Белый матовый

**incl. 1×6,8 W**

◀ A++-A

633 lm, 2700 K

**incl. 3×6,8 W**

◀ A++-A

3× 633 lm, 2700 K

EAN4000870 938768

**938.76 new**

EAN4000870 938751

**938.75 new**



☞ Hliník soustružený tłoczzone aluminium aluminiowa spirala

**incl. 1×6,8 W**

◀ A++-A

633 lm, 2700 K

**incl. 3×6,8 W**

◀ A++-A

3× 633 lm, 2700 K

EAN4000870 939024

**939.02 new**

EAN4000870 939031

**939.03 new**



☞ Kartáčované železo Żelazo szcztokowane Железо шероховатое

**incl. 1×6,8 W**

◀ A++-A

633 lm, 2700 K

**incl. 3×6,8 W**

◀ A++-A

3× 633 lm, 2700 K

EAN4000870 938775

**938.77 new**

EAN4000870 938782

**938.78 new**



☞ Chrom Chrom Хром

**incl. 1×6,8 W**

◀ A++-A

633 lm, 2700 K

**incl. 3×6,8 W**

◀ A++-A

3× 633 lm, 2700 K

EAN4000870 938799

**938.79 new**

EAN4000870 938805

**938.80 new**



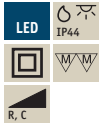
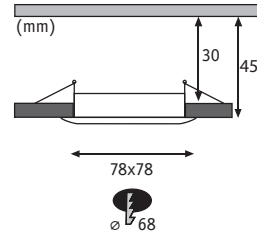

Hliník zinek Aluminium Cynk Алюминий Цинк



☞ Matně bílý Biel matowa Белый матовый

**incl. 1×6,8 W** <A++-A  
633 lm, 2700 K

**incl. 3×6,8 W** <A++-A  
3× 633 lm, 2700 K

EAN4000870 938881  
**938.88 new**

EAN4000870 938898  
**938.89 new**



☞ Hliník soustružený tłoczzone aluminium aluminiowa spirala

**incl. 1×6,8 W** <A++-A  
633 lm, 2700 K

**incl. 3×6,8 W** <A++-A  
3× 633 lm, 2700 K

EAN4000870 938942  
**938.94 new**

EAN4000870 938959  
**938.95 new**



☞ Kartáčované železo Żelazo szcztokowane Железо шероховатое

**incl. 1×6,8 W** <A++-A  
633 lm, 2700 K

**incl. 3×6,8 W** <A++-A  
3× 633 lm, 2700 K

EAN4000870 938911  
**938.91 new**

EAN4000870 938904  
**938.90 new**



☞ Chrom Chrom Хром

**incl. 1×6,8 W** <A++-A  
633 lm, 2700 K

**incl. 3×6,8 W** <A++-A  
3× 633 lm, 2700 K

EAN4000870 938928  
**938.92 new**

EAN4000870 938935  
**938.93 new**

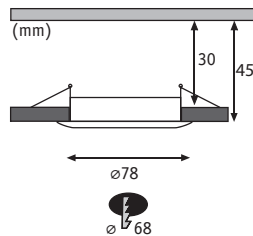

**Premium LED IP 65 230V Slim Coin Satin 51mm** Hliník zinek Aluminium Сунк Алюминий Цинк



☞ Matně bílý Biel matowa Белый матовый

**incl. 1×6,8 W** < A<sup>++</sup>-A  
633 lm, 2700 K

EAN4000870 938812  
**938.81 new**



☞ Kartáčované železo Żelazo szczotkowane Железо шероховатое

**incl. 1×6,8 W** < A<sup>++</sup>-A  
633 lm, 2700 K

EAN4000870 938829  
**938.82 new**



☞ Chrom Chrom Хром

**incl. 1×6,8 W** < A<sup>++</sup>-A  
633 lm, 2700 K

EAN4000870 938836  
**938.83 new**

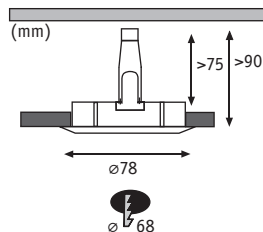

**Premium LED Nova 230V GU10 51mm**

Hliník zinek Aluminium Cynk Алюминий Цинк



☞ Matně bílý Biel matowa Белый матовый

**max. 35 W** <A++-E> **incl. 1×7 W,** <A+> <A++-E> **incl. 3×7 W,** <A+> <A++-E>  
 460 lm, 2700K 3×460 lm, 2700K  
 <math>\sphericalangle 36^\circ, 800 \text{ cd}</math> <math>\sphericalangle 36^\circ, 800 \text{ cd}</math>

EAN4000870 936313 **936.31 new** EAN4000870 935934 **935.93 new** EAN4000870 935972 **935.97 new**



☞ Hliník soustružený tłoczzone aluminium aluminiowa spirala

**max. 35 W** <A++-E> **incl. 1×7 W,** <A+> <A++-E> **incl. 3×7 W,** <A+> <A++-E>  
 460 lm, 2700K 3×460 lm, 2700K  
 <math>\sphericalangle 36^\circ, 800 \text{ cd}</math> <math>\sphericalangle 36^\circ, 800 \text{ cd}</math>

EAN4000870 936320 **936.32 new** EAN4000870 935941 **935.94 new** EAN4000870 935989 **935.98 new**



☞ Kartáčované železo Żelazo szcztokowane Железо шероховатое

**max. 35 W** <A++-E> **incl. 1×7 W,** <A+> <A++-E> **incl. 3×7 W,** <A+> <A++-E>  
 460 lm, 2700K 3×460 lm, 2700K  
 <math>\sphericalangle 36^\circ, 800 \text{ cd}</math> <math>\sphericalangle 36^\circ, 800 \text{ cd}</math>

EAN4000870 936337 **936.33 new** EAN4000870 935958 **935.95 new** EAN4000870 935996 **935.99 new**



☞ zlatá růžová różowe złoto розовое золото

**max. 35 W** <A++-E> **incl. 1×7 W,** <A+> <A++-E> **incl. 3×7 W,** <A+> <A++-E>  
 460 lm, 2700K 3×460 lm, 2700K  
 <math>\sphericalangle 36^\circ, 800 \text{ cd}</math> <math>\sphericalangle 36^\circ, 800 \text{ cd}</math>

EAN4000870 936344 **936.34 new** EAN4000870 935965 **935.96 new** EAN4000870 936009 **936.00 new**

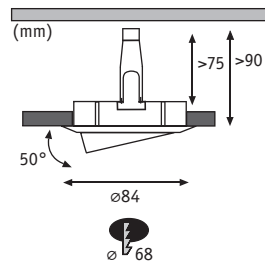

**Premium LED Nova 230V GU10 51mm**

Hliník zinek Aluminium Cynk Алюминий Цинк



☞ Matně bílý Biel matowa Белый матовый

<b>max. 35 W</b> < A++-E	<b>incl. 1×7 W, &lt; A+ &lt; A++-E</b> 460 lm, 2700K ∠ 36°, 800 cd	<b>incl. 3×7 W, &lt; A+ &lt; A++-E</b> 3×460 lm, 2700K ∠ 36°, 800 cd
EAN4000870 936399 <b>936.39 new</b>	EAN4000870 936016 <b>936.01 new</b>	EAN4000870 936054 <b>936.05 new</b>



☞ Hliník soustružený tłoczone aluminium aluminiowa spirala

<b>max. 35 W</b> < A++-E	<b>incl. 1×7 W, &lt; A+ &lt; A++-E</b> 460 lm, 2700K ∠ 36°, 800 cd	<b>incl. 3×7 W, &lt; A+ &lt; A++-E</b> 3×460 lm, 2700K ∠ 36°, 800 cd
EAN4000870 936405 <b>936.40 new</b>	EAN4000870 936023 <b>936.02 new</b>	EAN4000870 936061 <b>936.06 new</b>



☞ Kartáčované železo Żelazo szcztokowane Железо шероховатое

<b>max. 35 W</b> < A++-E	<b>incl. 1×7 W, &lt; A+ &lt; A++-E</b> 460 lm, 2700K ∠ 36°, 800 cd	<b>incl. 3×7 W, &lt; A+ &lt; A++-E</b> 3×460 lm, 2700K ∠ 36°, 800 cd
EAN4000870 936412 <b>936.41 new</b>	EAN4000870 936030 <b>936.03 new</b>	EAN4000870 936078 <b>936.07 new</b>



☞ zlatá růžová różowe złoto розовое золото

<b>max. 35 W</b> < A++-E	<b>incl. 1×7 W, &lt; A+ &lt; A++-E</b> 460 lm, 2700K ∠ 36°, 800 cd	<b>incl. 3×7 W, &lt; A+ &lt; A++-E</b> 3×460 lm, 2700K ∠ 36°, 800 cd
EAN4000870 936429 <b>936.42 new</b>	EAN4000870 936047 <b>936.04 new</b>	EAN4000870 936085 <b>936.08 new</b>

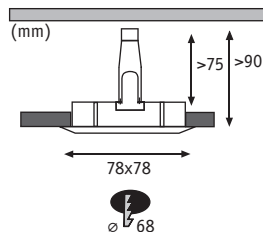

**Premium LED Nova 230V GU10 51mm**

Hliník zinek Aluminium Cynk Алюминий Цинк



☞ Matně bílý Biel matowa Белый матовый

**incl. 1×7 W, <math>\langle A^+ \rangle</math>** <math>\langle A^{++}-E \rangle</math>

460 lm, 2700K  
 <math>\sphericalangle 36^\circ</math>, 800 cd

EAN4000870 936092

**936.09 new**

**incl. 3×7 W, <math>\langle A^+ \rangle</math>** <math>\langle A^{++}-E \rangle</math>

3×460 lm, 2700K  
 <math>\sphericalangle 36^\circ</math>, 800 cd

EAN4000870 936139

**936.13 new**



☞ Hliník soustružený tłoczzone aluminium aluminiowa spirala

**incl. 1×7 W, <math>\langle A^+ \rangle</math>** <math>\langle A^{++}-E \rangle</math>

460 lm, 2700K  
 <math>\sphericalangle 36^\circ</math>, 800 cd

EAN4000870 936108

**936.10 new**

**incl. 3×7 W, <math>\langle A^+ \rangle</math>** <math>\langle A^{++}-E \rangle</math>

3×460 lm, 2700K  
 <math>\sphericalangle 36^\circ</math>, 800 cd

EAN4000870 936146

**936.14 new**



☞ Kartáčované železo Żelazo szcztokowane Железо шероховатое

**incl. 1×7 W, <math>\langle A^+ \rangle</math>** <math>\langle A^{++}-E \rangle</math>

460 lm, 2700K  
 <math>\sphericalangle 36^\circ</math>, 800 cd

EAN4000870 936115

**936.11 new**

**incl. 3×7 W, <math>\langle A^+ \rangle</math>** <math>\langle A^{++}-E \rangle</math>

3×460 lm, 2700K  
 <math>\sphericalangle 36^\circ</math>, 800 cd

EAN4000870 936153

**936.15 new**

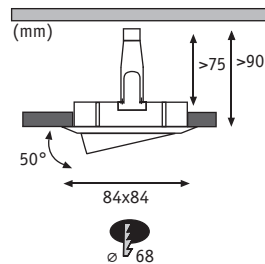

**Premium LED Nova 230V GU10 51mm**

Hliník zinek Aluminium Cynk Алюминий Цинк



☞ Matně bílý Biel matowa Белый матовый

**incl. 1×7 W, <math>\langle A^+ \rangle</math>** <math>\langle A^{++}-E \rangle</math>

460 lm, 2700K  
 <math>\sphericalangle 36^\circ</math>, 800 cd

EAN4000870 936177

**936.17 new**

**incl. 3×7 W, <math>\langle A^+ \rangle</math>** <math>\langle A^{++}-E \rangle</math>

3×460 lm, 2700K  
 <math>\sphericalangle 36^\circ</math>, 800 cd

EAN4000870 936214

**936.21 new**



☞ Hliník soustružený tłoczony aluminium aluminiowa spirala

**incl. 1×7 W, <math>\langle A^+ \rangle</math>** <math>\langle A^{++}-E \rangle</math>

460 lm, 2700K  
 <math>\sphericalangle 36^\circ</math>, 800 cd

EAN4000870 936184

**936.18 new**

**incl. 3×7 W, <math>\langle A^+ \rangle</math>** <math>\langle A^{++}-E \rangle</math>

3×460 lm, 2700K  
 <math>\sphericalangle 36^\circ</math>, 800 cd

EAN4000870 936221

**936.22 new**



☞ Kartáčované železo Żelazo szcztokowane Железо шероховатое

**incl. 1×7 W, <math>\langle A^+ \rangle</math>** <math>\langle A^{++}-E \rangle</math>

460 lm, 2700K  
 <math>\sphericalangle 36^\circ</math>, 800 cd

EAN4000870 936191

**936.19 new**

**incl. 3×7 W, <math>\langle A^+ \rangle</math>** <math>\langle A^{++}-E \rangle</math>

3×460 lm, 2700K  
 <math>\sphericalangle 36^\circ</math>, 800 cd

EAN4000870 936238

**936.23 new**



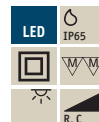
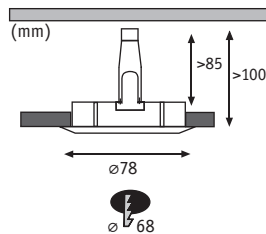

**Premium LED Nova IP65 230V GU10 51mm** Hliník zinek Aluminium Cynk Алюминий Цинк



☞ Matně bílý Biel matowa Белый матовый

**incl. 1×7 W, <math>\langle A^+ \rangle</math>** <math>\langle A^{++}-E \rangle</math>

460 lm, 2700K  
 <math>\sphericalangle 36^\circ</math>, 800 cd

EAN4000870 936252

**936.25 new**



☞ Kartáčované železo Żelazo szczotkowane Железо шероховатое

**incl. 1×7 W, <math>\langle A^+ \rangle</math>** <math>\langle A^{++}-E \rangle</math>

460 lm, 2700K  
 <math>\sphericalangle 36^\circ</math>, 800 cd

EAN4000870 936269

**936.26 new**



☞ Chrom Chrom Хром

**incl. 1×7 W, <math>\langle A^+ \rangle</math>** <math>\langle A^{++}-E \rangle</math>

460 lm, 2700K  
 <math>\sphericalangle 36^\circ</math>, 800 cd

EAN4000870 936276

**936.27 new**

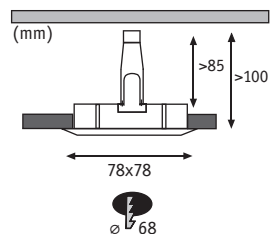

**Premium LED Nova IP65 230V GU10 51mm** Hliník zinek Aluminium Cynk Алюминий Цинк



Matně bílý Biel matowa Белый матовый

**incl. 1x7 W, <math>\langle A^+ \rangle</math>** <math>\langle A^{++}-E \rangle</math>

460 lm, 2700K

∠ 36°, 800 cd

EAN4000870 936283

**936.28 new**



Kartáčované železo Żelazo szczotkowane Железо шероховатое

**incl. 1x7 W, <math>\langle A^+ \rangle</math>** <math>\langle A^{++}-E \rangle</math>

460 lm, 2700K

∠ 36°, 800 cd

EAN4000870 936290

**936.29 new**



Chrom Chrom Хром

**incl. 1x7 W, <math>\langle A^+ \rangle</math>** <math>\langle A^{++}-E \rangle</math>

460 lm, 2700K

∠ 36°, 800 cd

EAN4000870 936306

**936.30 new**



**Premium Cardano GU10**

☒ Kov Metal Металл



☞ Titanová Titan Титан

**incl. 1x7 W, <math>\langle A^+ \rangle</math> <math>\langle A^{++}-E \rangle</math>**

460 lm, 2700 K  
 ✎ 36°, 800 cd

EAN4000870 929056

**929.05 new**

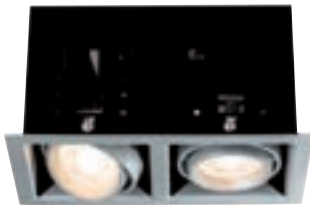
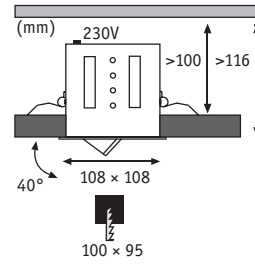

☞ Titanová Titan Титан

**incl. 2x7 W, <math>\langle A^+ \rangle</math> <math>\langle A^{++}-E \rangle</math>**

2x460 lm, 2700 K  
 ✎ 36°, 800 cd

EAN4000870 929063

**929.06 new**

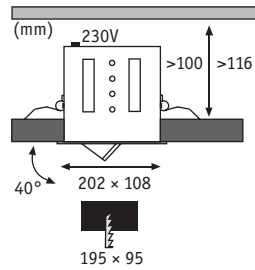

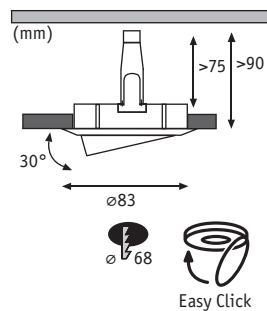

GU10  
283.00



LED 230V GU10 51mm

Kov Metal Metall



Matně bílý Biel matowa Белый матовый

incl. 3×6,5 W, A+ A++-E

3×425 lm, 2700K  
38°, 950 cd

EAN4000870 921050

921.05 new



Kartáčované železo Żelazo szczotkowane Железо шероховатое

incl. 3×6,5 W, A+ A++-E

3×425 lm, 2700K  
38°, 950 cd

EAN4000870 921029

921.02 new



Chrom Chrom Хром

incl. 3×6,5 W, A+ A++-E

3×425 lm, 2700K  
38°, 950 cd

EAN4000870 921012

921.01 new

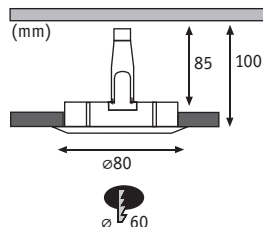

LED 230V GU10 51mm

Kov Metal Metall



☞ Matně bílý Biel matowa Белый матовый

**incl. 1×4,5 W, <math>\langle A^+ \rangle</math> <math>\langle A^{++-E} \rangle</math>**

340 lm, 2700K  
 <math>\sphericalangle 110^\circ</math>

EAN4000870 938546

**938.54 new**

**incl. 3×4,5 W, <math>\langle A^+ \rangle</math> <math>\langle A^{++-E} \rangle</math>**

3×340 lm, 2700K  
 <math>\sphericalangle 110^\circ</math>

EAN4000870 938515

**938.51 new**



☞ Kartáčované železo Żelazo szcztokowane Железо шероховатое

**incl. 1×4,5 W, <math>\langle A^+ \rangle</math> <math>\langle A^{++-E} \rangle</math>**

340 lm, 2700K  
 <math>\sphericalangle 110^\circ</math>

EAN4000870 938553

**938.55 new**

**incl. 3×4,5 W, <math>\langle A^+ \rangle</math> <math>\langle A^{++-E} \rangle</math>**

3×340 lm, 2700K  
 <math>\sphericalangle 110^\circ</math>

EAN4000870 938522

**938.52 new**



☞ Chrom Chrom Хром

**incl. 1×4,5 W, <math>\langle A^+ \rangle</math> <math>\langle A^{++-E} \rangle</math>**

340 lm, 2700K  
 <math>\sphericalangle 110^\circ</math>

EAN4000870 938560

**938.56 new**

**incl. 3×4,5 W, <math>\langle A^+ \rangle</math> <math>\langle A^{++-E} \rangle</math>**

3×340 lm, 2700K  
 <math>\sphericalangle 110^\circ</math>

EAN4000870 938539

**938.53 new**

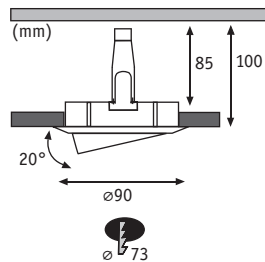

LED 230V GU10 51mm

Kov Metal Metall



☞ Matně bílý Biel matowa Белый матовый

**incl. 1×4,5 W, <math>\langle A^+ \rangle</math> <math>\langle A^{++} \rangle</math>-E**

340 lm, 2700K  
 <math>\sphericalangle 110^\circ</math>

EAN4000870 938485

**938.48 new**

**incl. 3×4,5 W, <math>\langle A^+ \rangle</math> <math>\langle A^{++} \rangle</math>-E**

3×340 lm, 2700K  
 <math>\sphericalangle 110^\circ</math>

EAN4000870 938454

**938.45 new**



☞ Kartáčované železo Żelazo szcztokowane Железо шероховатое

**incl. 1×4,5 W, <math>\langle A^+ \rangle</math> <math>\langle A^{++} \rangle</math>-E**

340 lm, 2700K  
 <math>\sphericalangle 110^\circ</math>

EAN4000870 938492

**938.49 new**

**incl. 3×4,5 W, <math>\langle A^+ \rangle</math> <math>\langle A^{++} \rangle</math>-E**

3×340 lm, 2700K  
 <math>\sphericalangle 110^\circ</math>

EAN4000870 938461

**938.46 new**



☞ Chrom Chrom Хром

**incl. 1×4,5 W, <math>\langle A^+ \rangle</math> <math>\langle A^{++} \rangle</math>-E**

340 lm, 2700K  
 <math>\sphericalangle 110^\circ</math>

EAN4000870 938508

**938.50 new**

**incl. 3×4,5 W, <math>\langle A^+ \rangle</math> <math>\langle A^{++} \rangle</math>-E**

3×340 lm, 2700K  
 <math>\sphericalangle 110^\circ</math>

EAN4000870 938478

**938.47 new**

*Kombinujte sami! Vše je možné!*

*Pokombinuj samemu! Wszystko jest możliwe!*

*Комбинируйте самостоятельно! Возможно всё!*

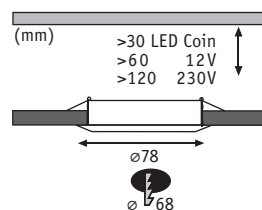
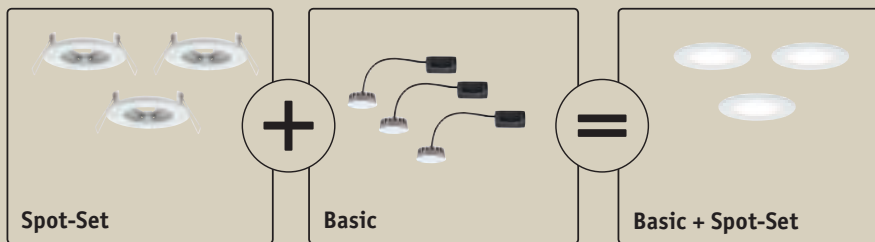

## 2Easy Spot-Set Premium Nova

Hliník zinek Aluminium Cynk Алюминий Цинк



Matně bílý Biel matowa Белый матовый

max. 35 W < A++-E

EAN4000870 936351

936.35 new



Hliník soustružený tłoczona aluminium aluminiowa spirаль

max. 35 W < A++-E

EAN4000870 936368

936.36 new



Kartáčované železo Żelazo szcztokowane Железо шероховатое

max. 35 W < A++-E

EAN4000870 936375

936.37 new

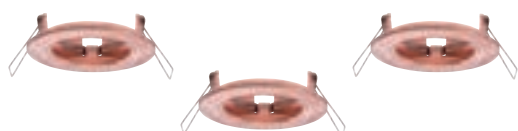

zlatá růžová różowe złoto розовое золото

max. 35 W < A++-E

EAN4000870 936382

936.38 new



*Kombinujte sami! Vše je možné!*

*Pokombinuj samemu! Wszystko jest możliwe!*

*Комбинируйте самостоятельно! Возможно всё!*

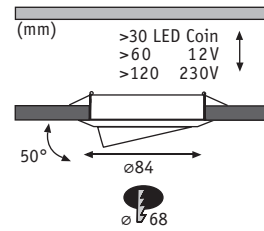
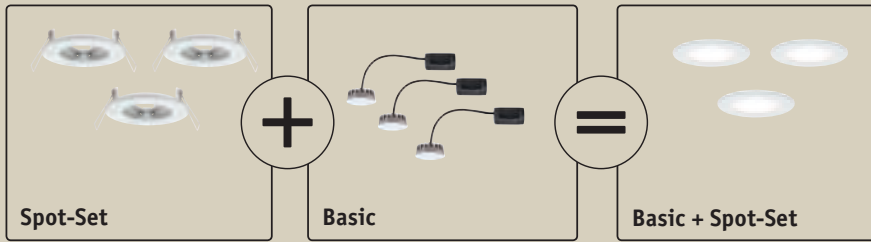

## 2Easy Spot-Set Premium Nova

☒ Hliník zinek Aluminium Cynk Алюминий Цинк

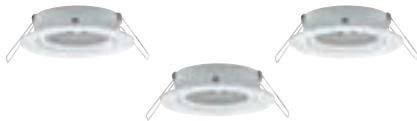

☞ Matně bílý Biel matowa Белый матовый

max. 35 W

◀ A++-E

EAN4000870 936436

936.43 new



☞ Hliník soustružený tłoczzone aluminium aluminiowa spirаль

max. 35 W

◀ A++-E

EAN4000870 936443

936.44 new



☞ Kartáčované železo Żelazo szcztokowane Железо шероховатое

max. 35 W

◀ A++-E

EAN4000870 936450

936.45 new

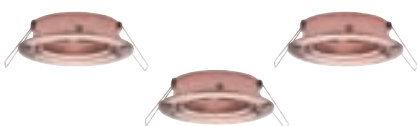

☞ zlatá růžová różowe złoto розовое золото

max. 35 W

◀ A++-E

EAN4000870 936467

936.46 new



## 2Easy Basic LED Coin 230V

Plast Tworzywo sztuczne Пластмасса

☞ Satén Satynowany Сатин



**incl. 3×6,8 W** A  
 415 lm LED  
 3× 592 lm (Modul) □  
 2700 K  
 ✎ 120°, 30000h  
 ON/OFF L 15000

EAN4000870 938867  
**938.86 new**

☞ Satén Satynowany Сатин









**incl. 3×6,8 W** A  
 425 lm LED  
 3× 633 lm (Modul) □  
 2700 K  
 ✎ 120°, 30000h  
 ON/OFF L 15000 R, C



EAN4000870 938874  
**938.87 new**



Bluetooth Low Energy  
2,4 GHz



-  ON/OFF
-  dimmable
-  tunable white
-  RGB+W
-  RGB



*Jedna aplikace pro všechny funkce  
Wszystkie funkcje w jednej aplikacji  
Одно приложение для всех функций*



**Prostory**

Nastavte si místnosti individuálně a přiřaďte svítidla jednotlivým místnostem.

**Pomieszczenia**

Stwórz swoje indywidualne pomieszczenia i przyporządkuj do nich oprawy oświetleniowe.

**Помещения**

Оформляйте помещения и располагайте светильники на свой вкус.

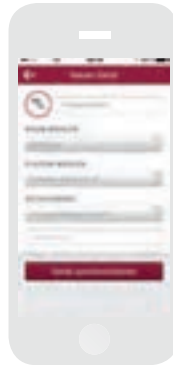

**Svítidla, žárovky, ovladače**

Vytvořte si individuální osvětlení přesně podle přání – přiřaďte mu název a symbol.

**Oprawy oświetleniowe, lampy, sterowniki**

Założ każdą ze swoich opraw oświetleniowych tak jak chcesz – nadaj jej nazwę i symbol.

**Светильники, лампы, контроллеры**

Управляйте светильниками по своему желанию, присваивая им названия и обозначения.



**Ovládání barvy**

Efektivní světlo RGB+W, regulace bílého světla nebo jen prosté stmívání – zalijte pokoj tou správnou atmosférou.

**Sterowanie kolorami**

RGB + światło dekoracyjne W, światło białe ze sterowaniem (tunable White) czy po prostu efekt ściemniania – stwórz odpowiedni nastrój w pomieszczeniu.

**Управление цветом**

Декоративный свет (основные цвета+белый), настраиваемый белый свет или просто приглушенная иллюминация – выберите то, что подходит вам под настроение.

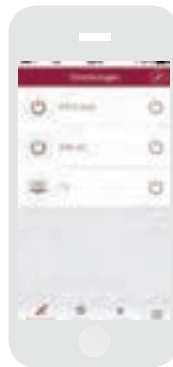

**Nálady**

Díky funkci oblíbených nastavení můžete kdykoli vše nastavit dle libosti stiskem tlačítka.

**Nastroje**

Ulubione ustawienia umożliwiają indywidualne ustawianie wszelkich parametrów przez naciśnięcie przycisku.

**Настройки**

Любимые настройки позволят вам в любое время воспроизвести излюбленный режим одним нажатием кнопки.



**Oblíbená svítidla**

Kterékoli svítidlo si můžete nastavit jako oblíbené, a rychle ho tak obsluhovat.

**Ulubione**

Każdą z opraw można dodać do Ulubionych, aby mieć do niej szybki dostęp.

**Избранное**

Вы можете добавить любой светильник в избранное для более быстрого доступа к нему.

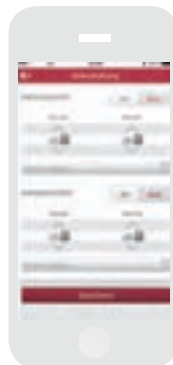

**Ovládání časovače**

Sami si můžete určit, v jakou dobu se mají světla automaticky zapnout nebo vypnout.

V době zapnutí se chytrý telefon nemusí nacházet v blízkosti.

**Sterowanie czasowe**

Określ, o której godzinie Twoja oprawa oświetleniowa ma się automatycznie włączyć lub wyłączyć.

W momencie włączania/wyłączania smartfon nie musi się znajdować w pobliżu.

**Управление временем**

Самостоятельно задавайте время автоматического включения и выключения светильников.







При этом нет необходимости, чтобы смартфон находился поблизости.



### Remote Control Boss

∅18 ↔48 ↗110 mm  
EAN4000870 500019

**500.01** 

-  Černá  Plast
-  Czarny  Tworzywo sztuczne
-  черный  Пластмасса









Ω Max. 400W  
C: Max. 75W



### EuroPlug Switch

max. 400W  
230V  
∅103 ↔62 ↗47 mm  
EAN4000870 500194

**500.19** 

-  Białá  Plast
-  Biały  Tworzywo sztuczne
-  Белый  Пластмасса









Ω Max. 400W  
C: Max. 75W



### EuroPlug Switch/Dimm

max. 400W  
230V  
∅103 ↔62 ↗47 mm  
EAN4000870 500200

**500.20** 



-  Białá  Plast
-  Biały  Tworzywo sztuczne
-  Белый  Пластмасса



### Nox

incl. 1×10,5W  
1090 lm, 2700-6500 K  
230V, 10,5 VA  
∅170 ↗40 mm  
EAN4000870 500088

**500.08** 

-  Matně bílý  Plast
-  Biel matowa  Tworzywo sztuczne
-  Белый матовый  Пластмасса



### Nox

incl. 1×14W  
1490 lm, 2700-6500 K  
230V, 14,5 VA  
∅220 ↗40 mm  
EAN4000870 500095

**500.09** 







-  Matně bílý  Plast
-  Biel matowa  Tworzywo sztuczne
-  Белый матовый  Пластмасса



### Nox

incl. 1×21W  
2100 lm, 2700-6500 K  
230V, 21 VA  
∅300 ↗40 mm  
EAN4000870 500101

**500.10** 

-  Matně bílý  Plast
-  Biel matowa  Tworzywo sztuczne
-  Белый матовый  Пластмасса



- ▶ Přehrávání hudby přímo ze smartphonu pomocí Bluetooth
- ▶ Praktická funkce stmívání pomocí Bluetooth

- ▶ Odtwarzanie muzyki bezpośrednio ze smartfona przez bluetooth
- ▶ Praktyczna funkcja ściemniania przez bluetooth







- ▶ Воспроизведение музыки прямо со смартфона через Bluetooth
- ▶ Практичная функция регулировки яркости с помощью Bluetooth



### Premium Line LED LightSound

incl. 1×6W / 1×2W   
630 lm, 2700 K  
∠ 110°  
230/12V, 12 VA  
∅39 ∅117 mm  
EAN4000870 920961

**920.96** 

-  Białá  Plast
-  Biały  Tworzywo sztuczne
-  Белый  Пластмасса



## Set IceLED

A++-A

incl. 4x4 W

4x 320 lm, 2700-6500 K

230/12 V, 36 VA

±160 mm 2,5 mm<sup>2</sup> ↔10 m

EAN4000870 500163

**500.16 new**Matný chrom/Bílá  KovChrom matowy/Biały  MetalХром матовый/Белый  Металл

LED



## Flaex LED Strip Set 5m RGB

A++-A

incl. 1x18 W

536 lm

↘ 120°

230/12 V, 24 VA

±3 mm ±10,5 mm ↔5 m

EAN4000870 500057

**500.05 new**Bílá  PlastBiały  Tworzywo sztuczneБелый  Пластмасса







### YourLED Switch/Dimm Controller

max. 60 W  
12 V  
⇅19 ⇄39 ↻80 mm  
EAN4000870 500385  
**500.38**  **new**





👉 Biłá  Plast  
👉 Biały  Tworzywo sztuczne  
👉 Белый  Пластмасса



### YourLED RGB Controller

max. 60 W  
12 V  
⇅19 ⇄39 ↻80 mm  
EAN4000870 500392  
**500.39**  **new**



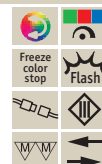

👉 Biłá  Plast  
👉 Biały  Tworzywo sztuczne  
👉 Белый  Пластмасса



### MaxLED Switch/Dimm Controller

max. 144 W  
24 V  
⇅19 ⇄39 ↻80 mm  
EAN4000870 500026  
**500.02**  **new**





👉 Biłá  Plast  
👉 Biały  Tworzywo sztuczne  
👉 Белый  Пластмасса



### MaxLED TunableWhite Controller

max. 144 W  
24 V  
⇅19 ⇄39 ↻80 mm  
EAN4000870 500033  
**500.03**  **new**





👉 Biłá  Plast  
👉 Biały  Tworzywo sztuczne  
👉 Белый  Пластмасса



### MaxLED RGBW Controller

max. 144 W  
24 V  
⇅19 ⇄39 ↻80 mm  
EAN4000870 500040  
**500.04**  **new**



👉 Biłá  Plast  
👉 Biały  Tworzywo sztuczne  
👉 Белый  Пластмасса





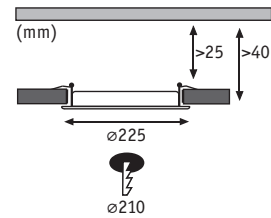

**Smart Panel BLE** A++-A

incl. 1x13,5 W  
1710 lm, 2700-6500 K  
230/24 V, 15 VA  
ø225 mm  
EAN4000870 500286  
**500.28 new**

LED  
ALU rost' frei

⚙ Matně bílý  Hliník/Plast  
 ⚙ Biel matowa   
 Alu/Tworzywo sztuczne  
 ⚙ Белый матовый   
 Алюминий/Пластмасса

**Smart Panel BLE** A++-A

incl. 1x13,5 W  
1710 lm, 2700-6500 K  
230/24 V, 15 VA  
ø225 mm  
EAN4000870 500293  
**500.29 new**

LED  
ALU rost' frei

⚙ Kartáčované železo   
 Hliník/Plast  
 ⚙ Želazo szczotkowane   
 Alu/Tworzywo sztuczne  
 ⚙ Железо шероховатое   
 Алюминий/Пластмасса

**Smart Panel BLE** A++-A

incl. 1x3,5 W  
270 lm, 2700 K  
230/12 V, 12 VA  
ø225 mm  
EAN4000870 500262  
**500.26 new**

LED  
ALU rost' frei

⚙ Matně bílý   Hliník/Plast  
 ⚙ Biel matowa   
 Alu/Tworzywo sztuczne  
 ⚙ Белый матовый   
 Алюминий/Пластмасса

**Smart Panel BLE** A++-A

incl. 1x3,5 W  
270 lm, 2700 K  
230/12 V, 12 VA  
ø225 mm  
EAN4000870 500279  
**500.27 new**

LED  
ALU rost' frei

⚙ Kartáčované železo   
 Hliník/Plast  
 ⚙ Želazo szczotkowane   
 Alu/Tworzywo sztuczne  
 ⚙ Железо шероховатое   
 Алюминий/Пластмасса

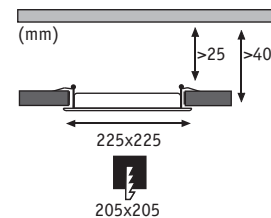
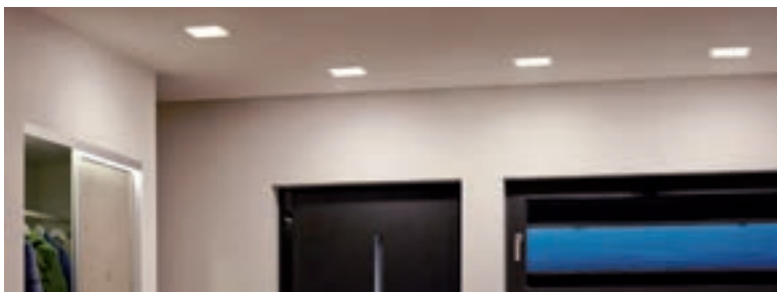

**Smart Panel BLE** A++-A

incl. 1x13,5 W  
1710 lm, 2700-6500 K  
230/24 V, 15 VA  
⇔225 ⇔225 mm  
EAN4000870 500361  
**500.36 new**

LED  
ALU rost' frei

⚙ Matně bílý   Hliník/Plast  
 ⚙ Biel matowa   
 Alu/Tworzywo sztuczne  
 ⚙ Белый матовый   
 Алюминий/Пластмасса

**Smart Panel BLE** A++-A

incl. 1x13,5 W  
1710 lm, 2700-6500 K  
230/24 V, 15 VA  
⇔225 ⇔225 mm  
EAN4000870 500378  
**500.37 new**

LED  
ALU rost' frei

⚙ Kartáčované železo   
 Hliník/Plast  
 ⚙ Želazo szczotkowane   
 Alu/Tworzywo sztuczne  
 ⚙ Железо шероховатое   
 Алюминий/Пластмасса

**Smart Panel BLE** A++-A

incl. 1x3,5 W  
270 lm, 2700 K  
230/12 V, 12 VA  
⇔225 ⇔225 mm  
EAN4000870 500347  
**500.34 new**

LED  
ALU rost' frei

⚙ Matně bílý   Hliník/Plast  
 ⚙ Biel matowa   
 Alu/Tworzywo sztuczne  
 ⚙ Белый матовый   
 Алюминий/Пластмасса

**Smart Panel BLE** A++-A

incl. 1x3,5 W  
270 lm, 2700 K  
230/12 V, 12 VA  
⇔225 ⇔225 mm  
EAN4000870 500354  
**500.35 new**

LED  
ALU rost' frei

⚙ Kartáčované železo   
 Hliník/Plast  
 ⚙ Želazo szczotkowane   
 Alu/Tworzywo sztuczne  
 ⚙ Железо шероховатое   
 Алюминий/Пластмасса

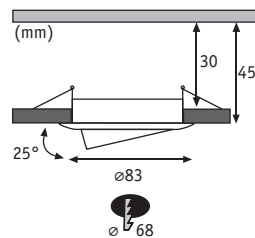
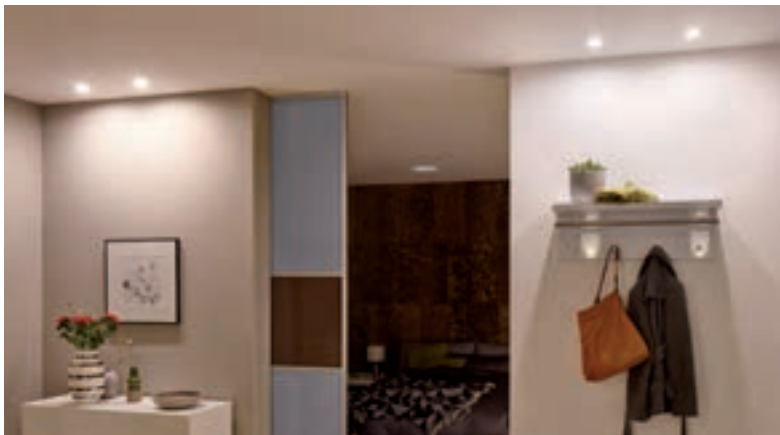

**Premium LED 230V Smart  
Coin BLE 51mm**

A++-A

incl. 1x5 W  
490 lm, 2700 K  
230/24 V, 6 VA  
ø83 mm  
EAN4000870 920947  
**920.94**



☞ Matně bílý ☞ Hliník zinek  
☞ Biel matowa ☞ Aluminium Cynk  
☞ Белый матовый ☞ Алюминий Цинк

**Premium LED 230V Smart  
Coin BLE 51mm**

A++-A

incl. 1x4,5 W  
560 lm, 2700-6500 K  
230/24 V, 6 VA  
ø83 mm  
EAN4000870 920954  
**920.95**



☞ Matně bílý ☞ Hliník zinek  
☞ Biel matowa ☞ Aluminium Cynk  
☞ Белый матовый ☞ Алюминий Цинк

**Premium LED 230V Smart  
Coin BLE 51mm**

A++-A

incl. 1x2,4 W  
80 lm  
230/24 V, 3 VA  
ø83 mm  
EAN4000870 920930  
**920.93**

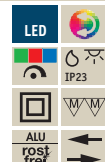

☞ Matně bílý ☞ Hliník zinek  
☞ Biel matowa ☞ Aluminium Cynk  
☞ Белый матовый ☞ Алюминий Цинк



**Premium LED 230V Smart  
Coin BLE 51mm**

A++-A

incl. 1x5 W  
490 lm, 2700 K  
230/24 V, 6 VA  
ø83 mm  
EAN4000870 938447  
**938.44**



☞ Kartáčované železo ☞ Hliník zinek  
☞ Żelazo szcztokowane ☞ Aluminium Cynk  
☞ Железо шероховатое ☞ Алюминий Цинк

**Premium LED 230V Smart  
Coin BLE 51mm**

A++-A

incl. 1x4,5 W  
560 lm, 2700-6500 K  
230/24 V, 6 VA  
ø83 mm  
EAN4000870 938430  
**938.43**



☞ Kartáčované železo ☞ Hliník zinek  
☞ Żelazo szcztokowane ☞ Aluminium Cynk  
☞ Железо шероховатое ☞ Алюминий Цинк

**Premium LED 230V Smart  
Coin BLE 51mm**

A++-A

incl. 1x2,4 W  
80 lm  
230/24 V, 3 VA  
ø83 mm  
EAN4000870 938423  
**938.42**

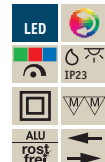

☞ Kartáčované železo ☞ Hliník zinek  
☞ Żelazo szcztokowane ☞ Aluminium Cynk  
☞ Железо шероховатое ☞ Алюминий Цинк



**LED Goal BLE 230 51mm**

A++-A

incl. 3x5,8 W  
515 lm, 2700 K  
∠ 110°  
230/24 V, 20 VA  
ø83 mm  
EAN4000870 500064  
**500.06 new**



☞ Matně bílý ☞ Hliník zinek  
☞ Biel matowa ☞ Aluminium Cynk  
☞ Белый матовый ☞ Алюминий Цинк

**LED Goal BLE 230 51mm**

A++-A

incl. 3x5,8 W  
515 lm, 2700 K  
∠ 110°  
230/24 V, 20 VA  
ø83 mm  
EAN4000870 500071  
**500.07 new**



☞ Kartáčované železo ☞ Hliník zinek  
☞ Żelazo szcztokowane ☞ Aluminium Cynk  
☞ Железо шероховатое ☞ Алюминий Цинк

Bílá/Bílá Plast  
 Biały/Biały Tworzywo sztuczne  
 Белый/Белый Пластмасса



Ω Max. 500W  
 C: Max. 75W



**Master Switch**

max. 500W  
 220-240V  
 ⚡26 ⚡47 ⚡136 mm  
 EAN4000870 500170  
**500.17 new**



**Master Switch/Dimm**

max. 500W  
 220-240V  
 ⚡26 ⚡47 ⚡136 mm  
 EAN4000870 500187  
**500.18 new**



Opál Opal Opal



W	⚡	∅ mm	⚡ mm	⚡	lm	cd	⚡	K	⌚	ON/OFF	📦	EAN	📄
9	E27	62	116	A+	650			2700	25.000	50000	1	4000870 500118	✓ <b>new 500.11</b>

Opál Opal Opal



W	⚡	∅ mm	⚡ mm	⚡	lm	cd	⚡	K	⌚	ON/OFF	📦	EAN	📄
9	E27	62	116	A+	650			2700-6500	25.000	50000	1	4000870 500125	✓ <b>new 500.12</b>



Boyn

Opál Opal Opal



W	⚡	∅ mm	⚡ mm	⚡	lm	cd	K	⌚	ON/OFF	📦	EAN	📄
9	E27	62	116	A	600		2700 + RGB	25.000	50000	1	4000870 500132	✓ <b>new 500.13</b>

Čirá Przewroczysty Прозрачный



W	⚡	∅ mm	⚡ mm	⚡	lm <sub>/90°</sub>	cd	⚡	K	⌚	ON/OFF	📦	EAN	📄
5	GU10	51	58	A+	300	845	35	2700	25.000	50000	1	4000870 500149	✓ <b>new 500.14</b>

Satén Satynowany Сатин



W	⚡	∅ mm	⚡ mm	⚡	lm <sub>/90°</sub>	cd	⚡	K	⌚	ON/OFF	📦	EAN	📄
5	GU10	51	58	A+	300	109	100	2700-6500	25.000	50000	1	4000870 500156	✓ <b>new 500.15</b>



Teen

Satén Satynowany Сатин



W	⚡	∅ mm	⚡ mm	⚡	lm <sub>/120°</sub>	cd	⚡	K	⌚	ON/OFF	📦	EAN	📄
3	GU10	51	58	B	25	15	100	RGB	25.000	50000	1	4000870 500217	✓ <b>new 500.21</b>

## Halo + LED Trafo 230/12V AC



- |  |   |   |
|--|---|---|
| <ul style="list-style-type: none"> <li>▶ Pro halogeny a diody LED</li> <li>▶ Žádné minimální zatížení</li> <li>▶ Max. 30 W LED / Max. 50 W Halogen 12 V AC</li> <li>▶ Stmívatelné s fázovým řízením na sestupné hraně</li> </ul> | <ul style="list-style-type: none"> <li>▶ Dla halogenu i LED</li> <li>▶ Brak obciążenia minimalnego</li> <li>▶ Maks. 30 W LED / maks. 50 W Halogen 12 V AC</li> <li>▶ Ściemnialne ze ściemniaczem z opóźnionym odcięciem fazy</li> </ul> | <ul style="list-style-type: none"> <li>▶ Для галогенных и светодиодных ламп</li> <li>▶ Минимальной нагрузки нет</li> <li>▶ Макс. 30 Вт светодиод / макс. 50 Вт галоген 12 В</li> <li>▶ Яркость регулируется реостатами с отсечением фазы заднего фронта импульса</li> </ul> |
|--|---|---|

### 230/12V, 50VA

max. 0-50 / LED 0-30 W

⌀28 ⇄44 ⌀127 mm

EAN4000870 977620

977.62 new

🎵 Bílá Plast  
 🎵 Biały Tworzywo sztuczne  
 🎵 Белый Пластмасса



LED max. 30W



Halogen 12V max. 50W





Satén Satynowany Сатин

W	⊖	∅ mm	⇅ mm	□	lm	lm/M	✂	K	⌚	ON/OFF	📦	EAN	☑	
6,8		49,5	30	A	415	592		2700	30.000	15000	1	4000870 938843	✓	new 938.84



Satén Satynowany Сатин

W	⊖	∅ mm	⇅ mm	□	lm	lm/M	✂	K	⌚	ON/OFF	📦	EAN	☑	
6,8		49,5	30	A	425	633		2700	30.000	15000	1	4000870 938850	✓	new 938.85



Čirá Przechroczysty Прозрачный

W	⊖	∅ mm	⇅ mm	□	lm	cd	✂	K	⌚	ON/OFF	📦	EAN	☑	
3	G9	16	50	A <sup>+</sup>	300			2700	15.000		10	4000870 284469	✓	new 284.46



Opál Opal Opal

W	⊖	∅ mm	⇅ mm	□	lm /90°	cd	✂	K	⌚	ON/OFF	📦	EAN	☑	
6,5	GU10	51	54	A <sup>+</sup>	350	820	36	2700	25.000	50000	7	4000870 284438	✓	new 284.43



Čirá Przechroczysty Прозрачный

W	⊖	∅ mm	⇅ mm	□	lm	cd	✂	K	⌚	ON/OFF	📦	EAN	☑	
9	R7s	24	118	A <sup>+</sup>	1000			2700	25.000	50000	10	4000870 284582	✓	new 284.58



Čirá Przechroczysty Прозрачный

W	⊖	∅ mm	⇅ mm	□	lm	cd	✂	K	⌚	ON/OFF	📦	EAN	☑	
5	R7s	24	78	A <sup>+</sup>	500			2700	25.000	50000	10	4000870 284599	✓	new 284.59



CRI/Ra ≥ 90

Opál Opal Opal

W	⊖	∅ mm	↑ mm	⬠	lm	cd	✂	K	⌚	ON/OFF	📦	EAN	☑	
6,5	E27	60	110	A+	470			2700	25.000	50000	6	4000870 284377	✓	new 284.37



CRI/Ra ≥ 90

Opál Opal Opal

W	⊖	∅ mm	↑ mm	⬠	lm	cd	✂	K	⌚	ON/OFF	📦	EAN	☑	
9,5	E27	60	120	A+	806			2700	25.000	50000	6	4000870 284384	✓	new 284.38



Opál Opal Opal

W	⊖	∅ mm	↑ mm	⬠	lm	cd	✂	K	⌚	ON/OFF	📦	EAN	☑	
10	E27	95	138	A+	1055			2700	15.000	50000	4	4000870 284476	✓	new 284.47



CRI/Ra ≥ 90

Opál Opal Opal

W	⊖	∅ mm	↑ mm	⬠	lm	cd	✂	K	⌚	ON/OFF	📦	EAN	☑	
4	E14	35	110	A+	250			2700	25.000	50000	8	4000870 284391	✓	new 284.39



CRI/Ra ≥ 90

Opál Opal Opal

W	⊖	∅ mm	↑ mm	⬠	lm	cd	✂	K	⌚	ON/OFF	📦	EAN	☑	
7	E14	38	112	A+	470			2700	25.000	50000	8	4000870 284407	✓	new 284.40



CRI/Ra ≥ 90

Opál Opal Opal

W	⊖	∅ mm	↑ mm	⬠	lm	cd	✂	K	⌚	ON/OFF	📦	EAN	☑	
4	E14	45	80	A+	250			2700	25.000	50000	7	4000870 284414	✓	new 284.41



CRI/Ra ≥ 90

Opál Opal Opal

W	⊖	∅ mm	↑ mm	⬠	lm	cd	✂	K	⌚	ON/OFF	📦	EAN	☑	
7	E14	45	89	A+	470			2700	25.000	50000	7	4000870 284421	✓	new 284.42



☞ Satén Satynowany Сатин



Deco Pipe

W	⊖	∅ mm	⇅ mm	◻	lm	cd	✂	K	⌚	ON/OFF	📦	EAN	☑	new
6	E27	38	150	A+	520			2700	15.000	50000	8	4000870 284360	✓	284.36



☞ Satén Satynowany Сатин



Deco Pipe

W	⊖	∅ mm	⇅ mm	◻	lm	cd	✂	K	⌚	ON/OFF	📦	EAN	☑	new
6	E14	38	145	A+	520			2700	15.000	50000	8	4000870 284353	✓	284.35



☞ Hřejivá bílá Ciepłobiały Тёплый Белый

W	⊖	∅ mm	⇅ mm	◻	lm /90°	cd	✂	K	⌚	ON/OFF	📦	EAN	☑	new
3,5	E14	50	84	A+	230	460	36	2700	15.000	50000	8	4000870 284605	✓	284.60



☞ Hřejivá bílá Ciepłobiały Тёплый Белый

W	⊖	∅ mm	⇅ mm	◻	lm /90°	cd	✂	K	⌚	ON/OFF	📦	EAN	☑	new
5	E27	63	95	A+	370	960	36	2700	15.000	50000	6	4000870 284612	✓	284.61



☞ Opál Opal Опал

W	⊖	∅ mm	⇅ mm	◻	lm /120°	cd	✂	K	⌚	ON/OFF	📦	EAN	☑	new
10	E27	80	114	A+	806		110	2700	25.000	50000	5	4000870 284445	✓	284.44



☞ Čirá Przewroczysty Прозрачный

W	⊖	∅ mm	⇅ mm	◻	lm /90°	cd	✂	K	⌚	ON/OFF	📦	EAN	☑	new
10	E27	121	136	A+	900	3400	25	2700	25.000	50000	3	4000870 284452	✓	284.45





Červená Czerwony Красный



W	⊖	∅ mm	↑ mm	◻	lm	cd	✂	K	⌚	ON/OFF	📦	EAN	☑	new
1	E27	60	104	A+	20				15.000		6	4000870 284483	✓	284.48



Zelená Zielony Зелёный



W	⊖	∅ mm	↑ mm	◻	lm	cd	✂	K	⌚	ON/OFF	📦	EAN	☑	new
1	E27	60	104	A+	25				15.000		6	4000870 284490	✓	284.49



Modrá Siny Синий



W	⊖	∅ mm	↑ mm	◻	lm	cd	✂	K	⌚	ON/OFF	📦	EAN	☑	new
1	E27	60	104	A	10				15.000		6	4000870 284506	✓	284.50



Oranžová Pomarańczowy Оранжевый



W	⊖	∅ mm	↑ mm	◻	lm	cd	✂	K	⌚	ON/OFF	📦	EAN	☑	new
1	E27	60	104	A+	25				15.000		6	4000870 284513	✓	284.51



Fialová Fioletowy Фиолетовый



W	⊖	∅ mm	↑ mm	◻	lm	cd	✂	K	⌚	ON/OFF	📦	EAN	☑	new
1	E27	60	104	B	5				15.000		6	4000870 284520	✓	284.52



Čirá Przewroczysty Прозрачный



W	⊖	∅ mm	⇅ mm	◻	lm	cd	⚡	K	⌚	ON/OFF	📦	EAN	☑	new
7,5	E27	60	104	A+	806			2700	15.000	50000	6	4000870 284230	✓	284.23



Čirá Przewroczysty Прозрачный



W	⊖	∅ mm	⇅ mm	◻	lm	cd	⚡	K	⌚	ON/OFF	📦	EAN	☑	new
7,5	E27	125	178	A+	806			2700	15.000	50000	3	4000870 284247	✓	284.24



Čirá Przewroczysty Прозрачный



W	⊖	∅ mm	⇅ mm	◻	lm	cd	⚡	K	⌚	ON/OFF	📦	EAN	☑	new
7,5	E27	64	140	A+	806			2700	15.000	50000	6	4000870 284254	✓	284.25



měděné zrcadlo lustrzana kopuła bańki z miedzi зеркальная головка из меди

W	⊖	∅ mm	⇅ mm	◻	lm	cd	⚡	K	⌚	ON/OFF	📦	EAN	☑	new
7,5	E27	60	104	A+	680			2700	15.000		6	4000870 284568	✓	284.56



měděné zrcadlo lustrzana kopuła bańki z miedzi зеркальная головка из меди

W	⊖	∅ mm	⇅ mm	◻	lm	cd	⚡	K	⌚	ON/OFF	📦	EAN	☑	new
7,5	E27	95	138	A+	680			2700	15.000		4	4000870 284575	✓	284.57



měděné zrcadlo lustrzana kopuła bańki z miedzi зеркальная головка из меди

W	⊖	∅ mm	⇅ mm	◻	lm	cd	⚡	K	⌚	ON/OFF	📦	EAN	☑	new
2,5	E14	45	80	A++	250			2700	15.000		8	4000870 284551	✓	284.55



**Pendulum** A++-E  
 max. 60 W, E27  
 230 V  
 ⌀70 mm ⌀200 cm ø45 mm  
 EAN4000870 503232  
**503.23** **new**

- 💡 283.79 2,5W
- 283.80 4W
- 283.81 6,5W
- 283.88 2,5W
- 283.89 6,5W
- 283.90 5W
- 283.91 7,5W
- 283.92 4W
- 283.93 2,5W
- 283.94 2,5W
- 283.95 4W

🌀 Červená/Nikl kartáčovaný Kov  
 🌀 Czerwony/Nikiel satynowane Metal  
 🌀 Красный/Никель, крацеванный Металл



**Pendulum** A++-E  
 max. 60 W, E27  
 230 V  
 ⌀70 mm ⌀200 cm ø45 mm  
 EAN4000870 503225  
**503.22** **new**

- 💡 283.79 2,5W
- 283.80 4W
- 283.81 6,5W
- 283.88 2,5W
- 283.89 6,5W
- 283.90 5W
- 283.91 7,5W
- 283.92 4W
- 283.93 2,5W
- 283.94 2,5W
- 283.95 4W

🌀 Šedá/Nikl kartáčovaný Kov  
 🌀 Szary/Nikiel satynowane Metal  
 🌀 Серый/Никель, крацеванный Металл

Štítek pro třídu energetické účinnosti se zobrazí následovně:

Etykieta klasy efektywności energetycznej przedstawiona jest następująco:

Этикетка класса энергоэффективности выглядит следующим образом:





	Příklad Przykład Пример	①  Světlo Oprawa Светильник	②  Zdroje světla Żarówka Средство освещения															
	<b>Arctus</b>  A <sup>++</sup> -E max. 60 W, E27 230 V ∅80 ∅275 mm EAN 4000870 703458 <b>703.45</b>	Toto světlo je kompatibilní se zdroji světla energetických tříd <b>A<sup>++</sup>-E</b> . Oprawa jest przystosowana do żarówek o klasie energetycznej <b>A<sup>++</sup>-E</b> . Этот светильник совместим с лампами энергетических классов <b>A<sup>++</sup>-E</b> .																
	<b>Futura</b>  A <sup>+</sup> -E incl. 2×3,5 W, GU10,  A 230 V ∅150 ∅275 ∅80 mm EAN 4000870 601792 <b>601.79</b>	Toto světlo je kompatibilní se zdroji světla energetických tříd <b>A<sup>+</sup>-E</b> . Oprawa jest przystosowana do żarówek o klasie energetycznej <b>A<sup>+</sup>-E</b> . Этот светильник совместим с лампами энергетических классов <b>A<sup>+</sup>-E</b> .	Toto světlo se prodává se zdrojem světla energetické třídy <b>A</b> . Oprawę sprzedaje się z żarówką o klasie energetycznej <b>A</b> . Этот светильник продается с лампой энергетического класса <b>A</b> .															
	<b>Egg LED</b>  A <sup>+</sup> -A incl. 1×4,2 W 490 lm, * 2700 K 230 V ∅148 ∅100 ∅100 mm EAN 4000870 603284 <b>603.28</b>	Toto světlo obsahuje zabudované světelné zdroje LED. W skład oprawy wchodzi wbudowane lampy LED. Этот светильник содержит встроенные светодиодные лампы.	Světelné zdroje v tomto světidle nelze vyměnit. Nie można wymieniać lamp w oprawie. Лампы в светильнике не могут быть заменены.															
	<b>HaloLED</b>  A <sup>+</sup> -A  B-D incl. 4×20 W, GU4,  C / 3×1,5 W 4×167 lm, 2900 K ∠ 30°, 500 cd 230/12 V, 105 VA ∅160 mm 2,5 mm <sup>2</sup> ∅12 m EAN 4000870 940709 <b>940.70</b>	Toto světlo obsahuje zabudované světelné zdroje LED a objímky pro zdroj světla energetických tříd <b>B-D</b> . W skład oprawy wchodzi wbudowane lampy LED i gniazda dla żarówek o klasach energetycznych <b>B-D</b> . Этот светильник содержит встроенные светодиодные лампы и имеет патроны для ламп энергетических классов <b>B-D</b> .	Toto světlo se prodává se zdrojem světla energetické třídy <b>C</b> . Oprawę sprzedaje się z żarówką o klasie energetycznej <b>C</b> . Этот светильник продается с лампой энергетического класса <b>C</b> .															
	Příklad Przykład Пример	③  Zdroje světla Żarówka Средство освещения																
	<table border="1"> <thead> <tr> <th>∅ mm</th> <th>∅ mm</th> <th>∅ mm</th> <th>∅ mm</th> <th>lm</th> </tr> </thead> <tbody> <tr> <td>E27</td> <td>66</td> <td>130</td> <td>A</td> <td>820</td> </tr> <tr> <td>E27</td> <td>60</td> <td>110</td> <td>A</td> <td>500</td> </tr> </tbody> </table>	∅ mm	∅ mm	∅ mm	∅ mm	lm	E27	66	130	A	820	E27	60	110	A	500	Třída energetické účinnosti: <b>A</b> Klasa efektywności energetycznej: <b>A</b> Класс энергосбережения: <b>A</b>	
∅ mm	∅ mm	∅ mm	∅ mm	lm														
E27	66	130	A	820														
E27	60	110	A	500														

\*světelný tok modul LED strumień światła modułu LED световой поток светодиодного модуля

Výrobky bez údaje třídy energetické účinnosti nespádají do oblasti použití EU-VO 874/2012.

Produkty bez danych na temat klasy efektywności energetycznej nie wchodzą w zakres zastosowań rozporządzenia delegowanego Komisji (UE) 874/2012.

Изделия без указания класса энергосбережения не попадают в область применения EU-VO 874/2012.

							
<b>180.00</b>	43	<b>500.12</b>	73	<b>666.36</b>	12	<b>666.96</b>	17
<b>180.01</b>	43	<b>500.13</b>	73	<b>666.37</b>	12	<b>666.97</b>	16
<b>180.02</b>	43	<b>500.14</b>	73	<b>666.38</b>	8	<b>666.98</b>	16
<b>180.03</b>	43	<b>500.15</b>	73	<b>666.39</b>	8	<b>666.99</b>	16
<b>180.04</b>	44	<b>500.16</b>	69	<b>666.40</b>	8	<b>667.00</b>	16
<b>180.05</b>	44	<b>500.17</b>	73	<b>666.41</b>	8	<b>667.01</b>	16
<b>180.06</b>	44	<b>500.18</b>	73	<b>666.42</b>	9	<b>667.02</b>	16
<b>180.07</b>	44	<b>500.19</b>	68	<b>666.43</b>	9	<b>667.03</b>	16
<b>180.08</b>	45	<b>500.20</b>	68	<b>666.44</b>	9	<b>667.04</b>	16
<b>180.09</b>	45	<b>500.21</b>	73	<b>666.45</b>	9	<b>667.05</b>	16
<b>237</b>	45	<b>500.26</b>	71	<b>666.46</b>	19	<b>667.06</b>	17
<b>284.23</b>	79	<b>500.27</b>	71	<b>666.47</b>	19	<b>667.07</b>	17
<b>284.24</b>	79	<b>500.28</b>	71	<b>666.48</b>	19	<b>667.08</b>	17
<b>284.25</b>	79	<b>500.29</b>	71	<b>666.49</b>	19	<b>667.09</b>	17
<b>284.35</b>	77	<b>500.34</b>	71	<b>666.54</b>	11	<b>667.10</b>	12
<b>284.36</b>	77	<b>500.35</b>	71	<b>666.55</b>	11	<b>667.11</b>	12
<b>284.37</b>	76	<b>500.36</b>	71	<b>666.56</b>	11	<b>667.12</b>	12
<b>284.38</b>	76	<b>500.37</b>	71	<b>666.57</b>	11	<b>667.13</b>	12
<b>284.39</b>	76	<b>500.38</b>	70	<b>666.62</b>	11	<b>667.14</b>	13
<b>284.40</b>	76	<b>500.39</b>	70	<b>666.63</b>	11	<b>667.15</b>	13
<b>284.41</b>	76	<b>503.22</b>	80	<b>666.64</b>	11	<b>667.16</b>	13
<b>284.42</b>	76	<b>503.23</b>	80	<b>666.65</b>	11	<b>667.17</b>	13
<b>284.43</b>	75	<b>600.04</b>	27	<b>666.66</b>	9	<b>667.18</b>	13
<b>284.44</b>	77	<b>600.06</b>	27	<b>666.67</b>	9	<b>667.19</b>	13
<b>284.45</b>	77	<b>600.07</b>	27	<b>666.68</b>	9	<b>706.22</b>	5
<b>284.46</b>	75	<b>600.08</b>	27	<b>666.69</b>	9	<b>707.15</b>	39
<b>284.47</b>	76	<b>600.09</b>	27	<b>666.70</b>	14	<b>707.16</b>	39
<b>284.48</b>	78	<b>600.11</b>	27	<b>666.71</b>	14	<b>707.17</b>	39
<b>284.49</b>	78	<b>600.12</b>	27	<b>666.72</b>	14	<b>707.18</b>	39
<b>284.50</b>	78	<b>600.15</b>	27	<b>666.74</b>	14	<b>707.19</b>	39
<b>284.51</b>	78	<b>600.53</b>	27	<b>666.75</b>	14	<b>707.20</b>	5
<b>284.52</b>	78	<b>600.55</b>	27	<b>666.76</b>	14	<b>707.21</b>	5
<b>284.55</b>	79	<b>603.24</b>	26	<b>666.78</b>	15	<b>707.26</b>	38
<b>284.56</b>	79	<b>603.25</b>	26	<b>666.79</b>	15	<b>707.27</b>	38
<b>284.57</b>	79	<b>603.26</b>	26	<b>666.80</b>	15	<b>707.32</b>	2
<b>284.58</b>	75	<b>603.27</b>	26	<b>666.81</b>	15	<b>707.33</b>	3
<b>284.59</b>	75	<b>603.28</b>	10	<b>666.82</b>	18	<b>707.34</b>	3
<b>284.60</b>	77	<b>603.29</b>	10	<b>666.83</b>	18	<b>707.35</b>	2
<b>284.61</b>	77	<b>603.30</b>	10	<b>666.84</b>	18	<b>707.36</b>	2
<b>500.01</b>	68	<b>603.31</b>	10	<b>666.85</b>	18	<b>707.37</b>	3
<b>500.02</b>	70	<b>666.18</b>	19	<b>666.86</b>	15	<b>707.76</b>	41
<b>500.03</b>	70	<b>666.19</b>	19	<b>666.87</b>	15	<b>707.77</b>	41
<b>500.04</b>	70	<b>666.20</b>	19	<b>666.88</b>	15	<b>708.00</b>	36
<b>500.05</b>	69	<b>666.21</b>	19	<b>666.89</b>	15	<b>708.01</b>	36
<b>500.06</b>	72	<b>666.30</b>	10	<b>666.90</b>	18	<b>708.02</b>	36
<b>500.07</b>	72	<b>666.31</b>	10	<b>666.91</b>	18	<b>708.03</b>	36
<b>500.08</b>	68	<b>666.32</b>	10	<b>666.92</b>	18	<b>708.04</b>	4
<b>500.09</b>	68	<b>666.33</b>	10	<b>666.93</b>	17	<b>708.05</b>	4
<b>500.10</b>	68	<b>666.34</b>	12	<b>666.94</b>	17	<b>708.06</b>	4
<b>500.11</b>	73	<b>666.35</b>	12	<b>666.95</b>	17	<b>708.07</b>	41

	☞		☞		☞		☞
<b>708.08</b>	41	<b>936.27</b>	57	<b>938.72</b>	48	<b>952.92</b>	28
<b>708.09</b>	38	<b>936.28</b>	58	<b>938.73</b>	48	<b>952.93</b>	28
<b>708.10</b>	38	<b>936.29</b>	58	<b>938.74</b>	48	<b>952.94</b>	35
<b>708.11</b>	40	<b>936.30</b>	58	<b>938.75</b>	50	<b>952.95</b>	35
<b>708.12</b>	40	<b>936.31</b>	53	<b>938.76</b>	50	<b>952.96</b>	35
<b>708.13</b>	40	<b>936.32</b>	53	<b>938.77</b>	50	<b>953.25</b>	35
<b>708.14</b>	40	<b>936.33</b>	53	<b>938.78</b>	50	<b>953.26</b>	35
<b>708.27</b>	37	<b>936.34</b>	53	<b>938.79</b>	50	<b>953.27</b>	35
<b>708.28</b>	37	<b>936.35</b>	63	<b>938.80</b>	50	<b>953.28</b>	35
<b>708.29</b>	37	<b>936.36</b>	63	<b>938.81</b>	52	<b>953.29</b>	29
<b>708.30</b>	37	<b>936.37</b>	63	<b>938.82</b>	52	<b>953.30</b>	32
<b>920.93</b>	72	<b>936.38</b>	63	<b>938.83</b>	52	<b>953.31</b>	29
<b>920.94</b>	72	<b>936.39</b>	54	<b>938.84</b>	75	<b>953.33</b>	32
<b>920.95</b>	72	<b>936.40</b>	54	<b>938.85</b>	75	<b>953.35</b>	29
<b>920.96</b>	68	<b>936.41</b>	54	<b>938.86</b>	65	<b>953.36</b>	33
<b>921.01</b>	60	<b>936.42</b>	54	<b>938.87</b>	65	<b>953.37</b>	30
<b>921.02</b>	60	<b>936.43</b>	64	<b>938.88</b>	51	<b>953.38</b>	30
<b>921.05</b>	60	<b>936.44</b>	64	<b>938.89</b>	51	<b>953.39</b>	30
<b>929.05</b>	59	<b>936.45</b>	64	<b>938.90</b>	51	<b>953.40</b>	30
<b>929.06</b>	59	<b>936.46</b>	64	<b>938.91</b>	51	<b>953.41</b>	31
<b>935.93</b>	53	<b>938.42</b>	72	<b>938.92</b>	51	<b>953.42</b>	33
<b>935.94</b>	53	<b>938.43</b>	72	<b>938.93</b>	51	<b>953.43</b>	33
<b>935.95</b>	53	<b>938.44</b>	72	<b>938.94</b>	51	<b>953.44</b>	33
<b>935.96</b>	53	<b>938.45</b>	62	<b>938.95</b>	51	<b>953.45</b>	34
<b>935.97</b>	53	<b>938.46</b>	62	<b>938.96</b>	47	<b>953.46</b>	34
<b>935.98</b>	53	<b>938.47</b>	62	<b>938.97</b>	47	<b>953.55</b>	26
<b>935.99</b>	53	<b>938.48</b>	62	<b>938.98</b>	49	<b>953.56</b>	26
<b>936.00</b>	53	<b>938.49</b>	62	<b>938.99</b>	49	<b>953.57</b>	26
<b>936.01</b>	54	<b>938.50</b>	62	<b>939.00</b>	48	<b>953.58</b>	26
<b>936.02</b>	54	<b>938.51</b>	61	<b>939.01</b>	48	<b>953.59</b>	27
<b>936.03</b>	54	<b>938.52</b>	61	<b>939.02</b>	50	<b>953.62</b>	32
<b>936.04</b>	54	<b>938.53</b>	61	<b>939.03</b>	50	<b>953.63</b>	32
<b>936.05</b>	54	<b>938.54</b>	61	<b>941.31</b>	25	<b>954.50</b>	31
<b>936.06</b>	54	<b>938.55</b>	61	<b>941.32</b>	25	<b>954.51</b>	31
<b>936.07</b>	54	<b>938.56</b>	61	<b>941.33</b>	20	<b>954.59</b>	29
<b>936.08</b>	54	<b>938.57</b>	47	<b>941.34</b>	21	<b>954.61</b>	29
<b>936.09</b>	55	<b>938.58</b>	47	<b>941.35</b>	21	<b>954.62</b>	29
<b>936.10</b>	55	<b>938.59</b>	47	<b>941.36</b>	23	<b>954.63</b>	29
<b>936.11</b>	55	<b>938.60</b>	47	<b>941.37</b>	25	<b>954.64</b>	31
<b>936.13</b>	55	<b>938.61</b>	47	<b>941.38</b>	25	<b>977.62</b>	74
<b>936.14</b>	55	<b>938.62</b>	47	<b>941.39</b>	25	<b>998.67</b>	6
<b>936.15</b>	55	<b>938.63</b>	49	<b>941.40</b>	25	<b>998.68</b>	7
<b>936.17</b>	56	<b>938.64</b>	49	<b>941.41</b>	26	<b>999.00</b>	7
<b>936.18</b>	56	<b>938.65</b>	49	<b>941.42</b>	20	<b>999.05</b>	6
<b>936.19</b>	56	<b>938.66</b>	49	<b>941.43</b>	24	<b>999.06</b>	6
<b>936.21</b>	56	<b>938.67</b>	49	<b>941.44</b>	22	<b>999.07</b>	6
<b>936.22</b>	56	<b>938.68</b>	49	<b>941.45</b>	23	<b>999.08</b>	7
<b>936.23</b>	56	<b>938.69</b>	48	<b>941.46</b>	22	<b>999.09</b>	7
<b>936.25</b>	57	<b>938.70</b>	48	<b>941.47</b>	25	<b>999.10</b>	7
<b>936.26</b>	57	<b>938.71</b>	48	<b>952.91</b>	28		



